

casa
lumi

www.casalumi.de

Sie erhalten das gesamte Sortiment von
Holtkötter bei Casa Lumi, dem Fachhändler
für exklusive Manufaktur-Leuchten.

Wir beraten Sie gerne!



HOLTKÖTTER

2024 / 2025

Unser Gründer Franz Holtkötter zeichnete in den 1960er Jahren ein Firmenlogo, das über 40 Jahre das Logo der Firma war. Es ziert nun das Titelbild unseres Kataloges.

holtkötter

1964 - 2024

QUALITÄT MADE IN GERMANY

Eine Jubiläumszeitreise vom ersten Kronleuchter im Jahre 1964 bis hin zu innovativsten, funktionellen LED-Leuchten im Jahre 2024.

Das Familienunternehmen Holtkötter wurde 1964 im westfälischen Bad Waldliesborn von Franz Holtkötter, einem erfahrenen Schlossermeister, mit der Affinität für Materialien und Oberflächen und der Leidenschaft für Licht gegründet.

Holtkötter etablierte sich schnell als Hersteller hochwertiger Wohnraumleuchten in der Lichtbranche. Der erste Erfolg ließ 1964 nicht lange auf sich warten: schon vor der Gründung fand Holtkötter seinen ersten Kunden für Messingkronleuchter in New York. Dies legte den Grundstein für die internationale Ausrichtung des Unternehmens. Bis heute schätzen uns unsere Kunden aus den Niederlanden, Luxemburg, Belgien, Frankreich, Schweiz, Österreich, Lichtenstein, Brasilien, Australien, Kanada, Dänemark, Norwegen und Schweden.

Im Jahr 1990 wurde der Produktionsstandort in Bad Waldliesborn um eine weitere Betriebsstätte in Liesborn erweitert, die nur 5 Kilometer vom ursprünglichen Standort entfernt liegt. Diese Expansion ermöglichte eine deutliche Steigerung der Fertigungskapazitäten. Bis heute beherbergen die beiden Werke verschiedenste Abteilungen, die für die Herstellung der hochwertigen Leuchten zuständig sind. Die Kombination aus traditionellem Handwerk und modernster Technik garantiert die höchste Qualität der Leuchten.

Werkzeuge und neue Leuchtenmodelle werden im hauseigenen Werkzeugbau entwickelt. Das eintreffende Rohmaterial, meist Aluminium oder Messing, wird auf Dreh- und Fräsmaschinen zu eleganten Formen verarbeitet. In der Schleiferei, Galvanik und Lackiererei wird das Material veredelt und erhält seine unverwechselbare Oberfläche. Mit höchster Sorgfalt wird das Material zusammengeführt, montiert, einer Qualitätskontrolle unterzogen und verpackt.

Während viele Leuchtenhersteller im Zuge der Globalisierung ihre Produktion nach Fernost verlagert haben, bleibt Holtkötter seinen Wurzeln treu und fertigt weiterhin nach höchsten Standards in Deutschland.

Die gesammelte Erfahrung von sechs Jahrzehnten, die exzellente Handwerkskunst und die umfassende Fertigungstiefe ermöglichen es uns eine Qualität herzustellen, die weltweit kaum übertroffen wird.

Mit unserer starken Basis in traditioneller deutscher Handwerkskunst, erfahrenen Mitarbeitern und einem klaren Fokus auf Innovation und Qualität made in Germany, ist Holtkötter gut positioniert, um auch in Zukunft erfolgreich zu sein.

inhalt

DIALUX	4-5
Plissee	6-25
Liv	26-31
Golyo	32-35
Fidelio	36-49
Favor	50-61
Naxos	62-69
Janus	70-77
SuperNova	78-105
Type	106-113

Avior	114-121
Xena	122-127
Epsilon	128-135
Aura	136-147
Nova	148-165
Plano	166-185
Flex	186-205
Vita	206-211
Fifties	212-221
Holtkötter klassik	222-237

dialux

Als Hersteller von hochwertigen Wohnraumleuchten haben wir nicht nur das Ziel, Räume zu erhellen, sondern durch die geschickte Anwendung unserer Leuchten eine einzigartige Atmosphäre und Stimmung zu schaffen. Die Auswirkungen von Licht im Alltag sind zwar selbstverständlich, werden jedoch oft unterschätzt und nicht vollständig genutzt.

Virtuelle Licht- und Raumplanungen können hier eine Brücke bauen und die Wirkung der Beleuchtung auf den Raum visualisieren. Es besteht daher nun die Möglichkeit, unsere Leuchten auf Anfrage in verschiedenen 3D-Formaten bei uns abzurufen und in Ihre Planungen zu integrieren.

Außerdem haben wir uns der Plattform DIALux als Silber-Mitglied angeschlossen. Im Planungsprogramm DIALux Evo sind viele unserer Leuchten direkt nutzbar. Jede dieser Leuchten wurde eigens einer Lichtmessung in zertifizierten Laboren unterzogen. Mit DIALux besteht nun die Möglichkeit, unsere Leuchten in Ihre Lichtplanungen zu integrieren und die Qualität selbst zu erleben.

Wir freuen uns auf das neue Geschäftsfeld.

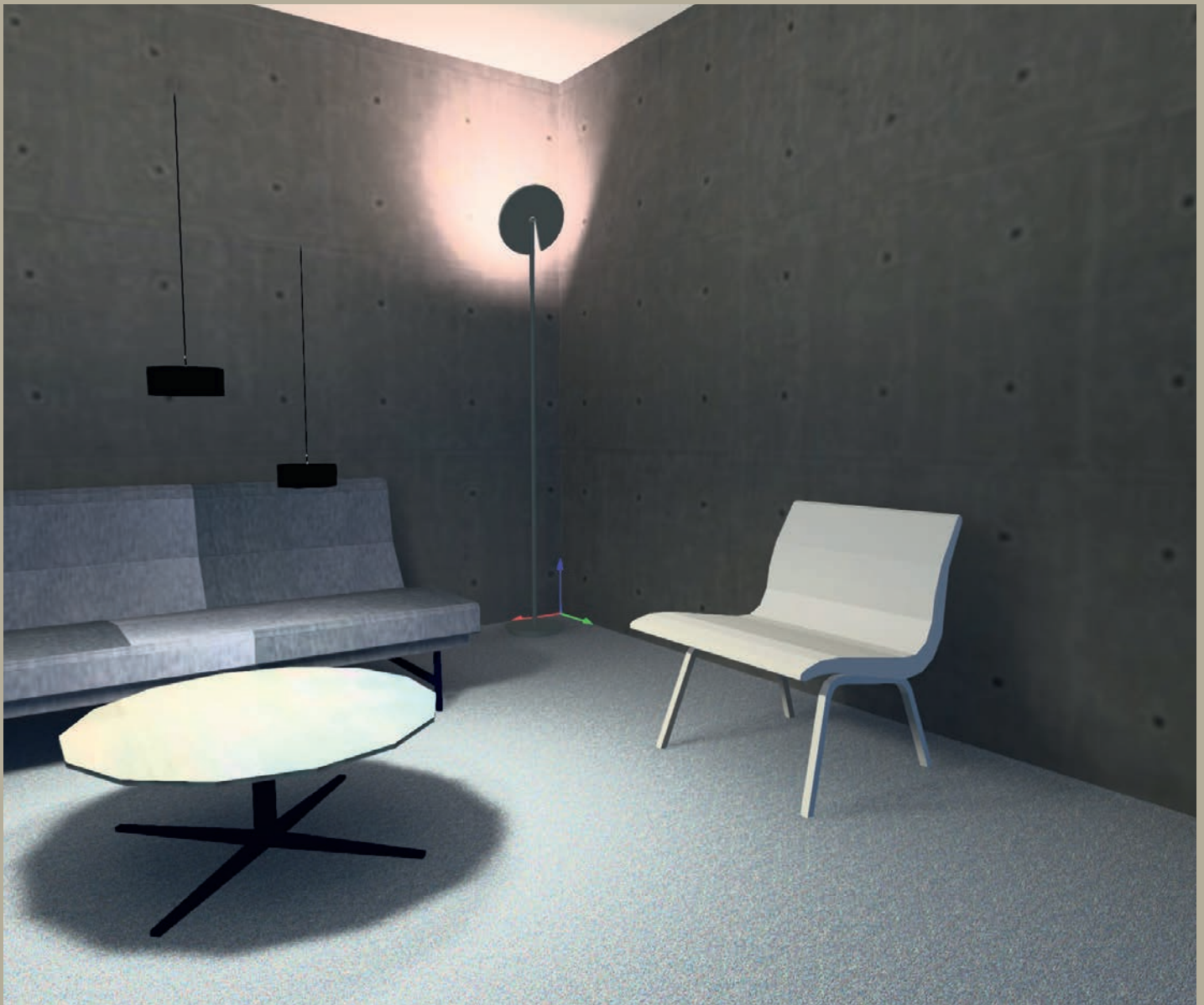



9940-1-62; 2052-2-62

plissee

Plissee S

Milieubild	8-9
Technische Daten	10-11

Plissee T1

Milieubild	12-13
Technische Daten	14-15

Plissee T2

Milieubild	16-17
Technische Daten	18-19

Plissee W

Technische Daten	20-21
------------------	-------

Plissee D

Produktionsbild	22-23
Technische Daten	24-25

plissee s



2410-1-55



plissee s

Technische Daten

1x E27 max. 11 Watt
nur LED-Leuchtmittel
230V
Ein-/Ausshalter

Ausführungen

- | | |
|-------------|----------------|
| ● 2410-1-19 | Eloxal Messing |
| ● 2410-1-55 | Schwarz |
| ● 2410-1-62 | Platin |
| ● 2410-1-79 | Aluminium matt |

Mundgeblasenes Glas



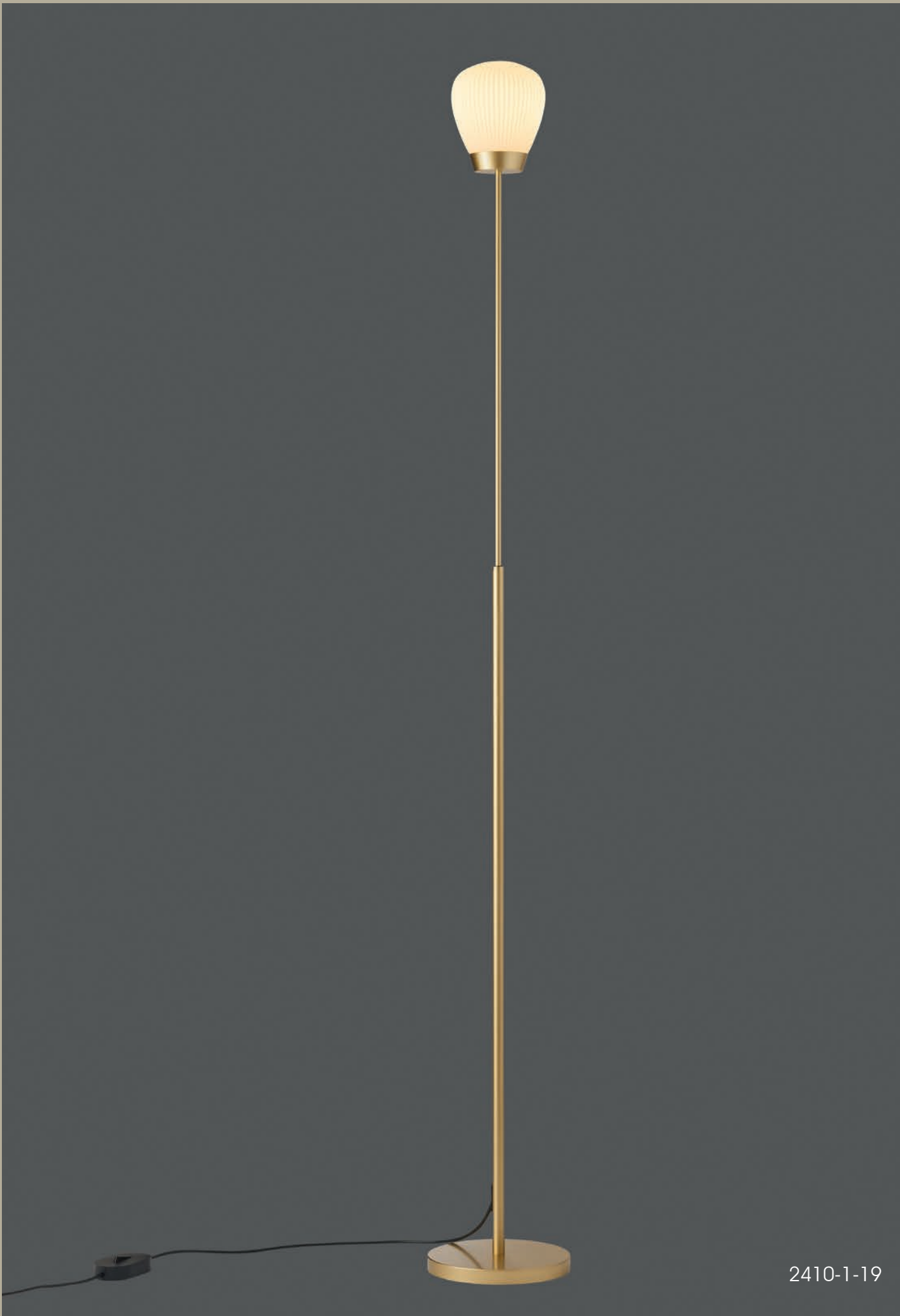

2410-1-19

plissee t1



2411-1-62



plissee t1

Technische Daten

1x E27 max. 11 Watt
nur LED-Leuchtmittel
230V
Ein-/Ausshalter

Ausführungen

- 2411-1-19 Eloxal Messing
- 2411-1-55 Schwarz
- 2411-1-62 Platin
- 2411-1-79 Aluminium matt

Mundgeblasenes Glas

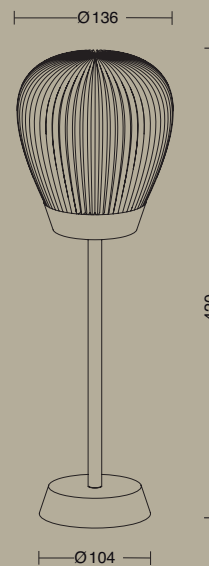

2411-1-62

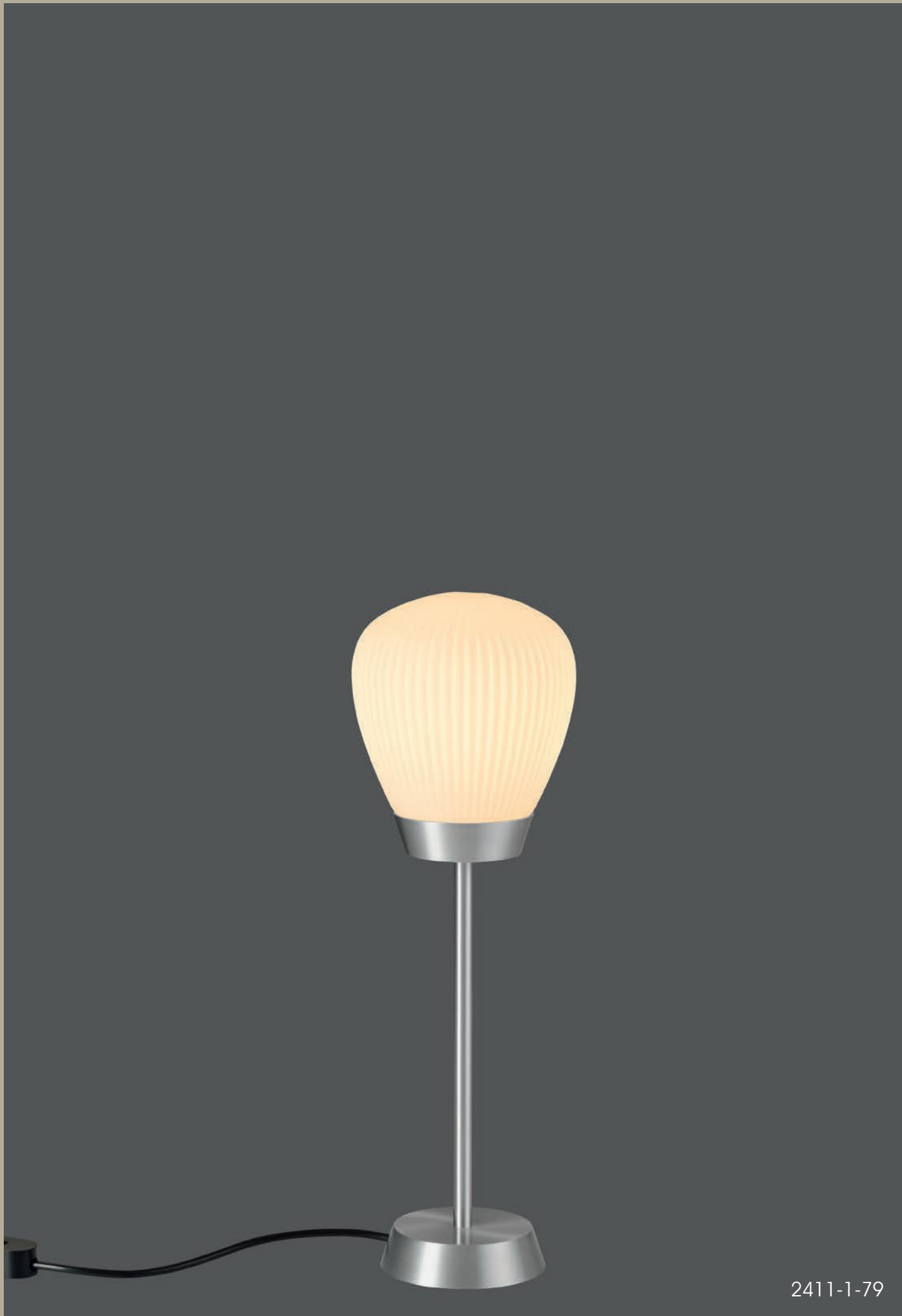

2411-1-79



2413-1-79 + 110550-79; 2412-1-79

plissee t2



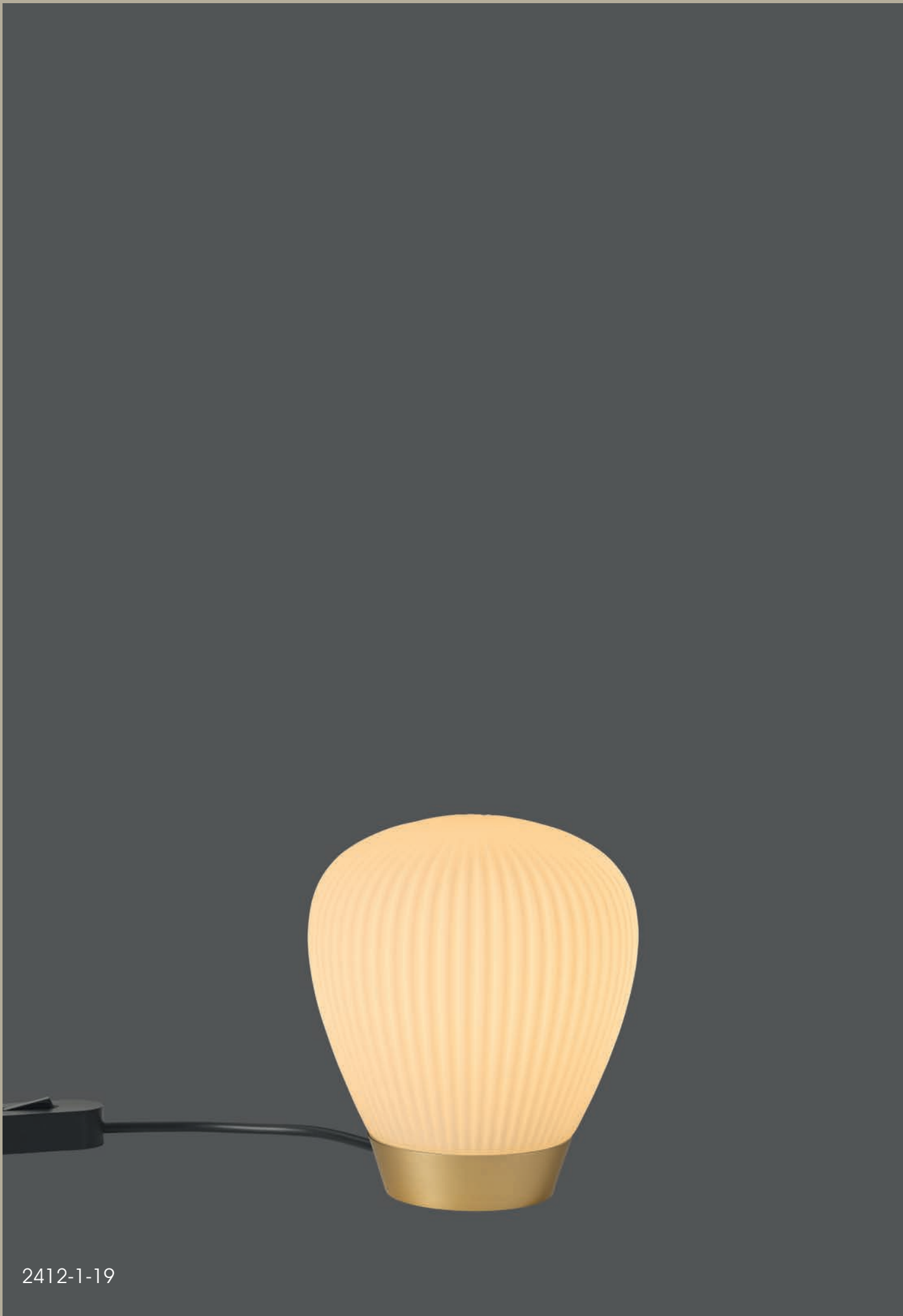

2412-1-19

plissee t2

Technische Daten

1x E27 max. 11 Watt
nur LED-Leuchtmittel
230V
Ein-/Ausschalter

Ausführungen

- | | |
|-------------|----------------|
| ● 2412-1-19 | Eloxal Messing |
| ● 2412-1-55 | Schwarz |
| ● 2412-1-62 | Platin |
| ● 2412-1-79 | Aluminium matt |

Mundgeblasenes Glas

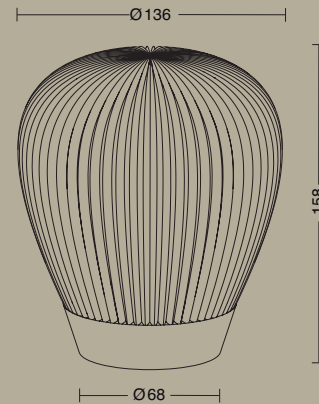

2412-1-79

plissee w

Technische Daten

1x E27 max. 11 Watt
nur LED-Leuchtmittel
230V

Ausführungen

- 2413-1-19 Eloxal Messing
- 2413-1-55 Schwarz
- 2413-1-62 Platin
- 2413-1-79 Aluminium matt

Wandschild

- 110550-19 Eloxal Messing
- 110550-55 Schwarz
- 110550-62 Platin
- 110550-79 Aluminium matt

Mundgeblasenes Glas

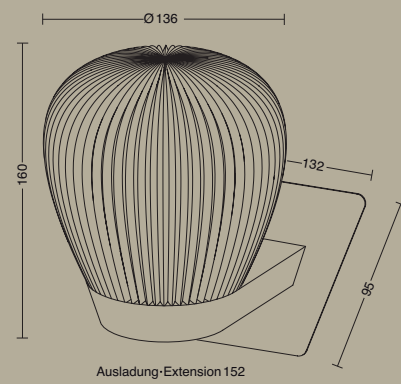
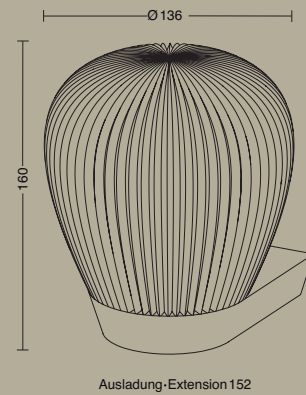

2413-1-79

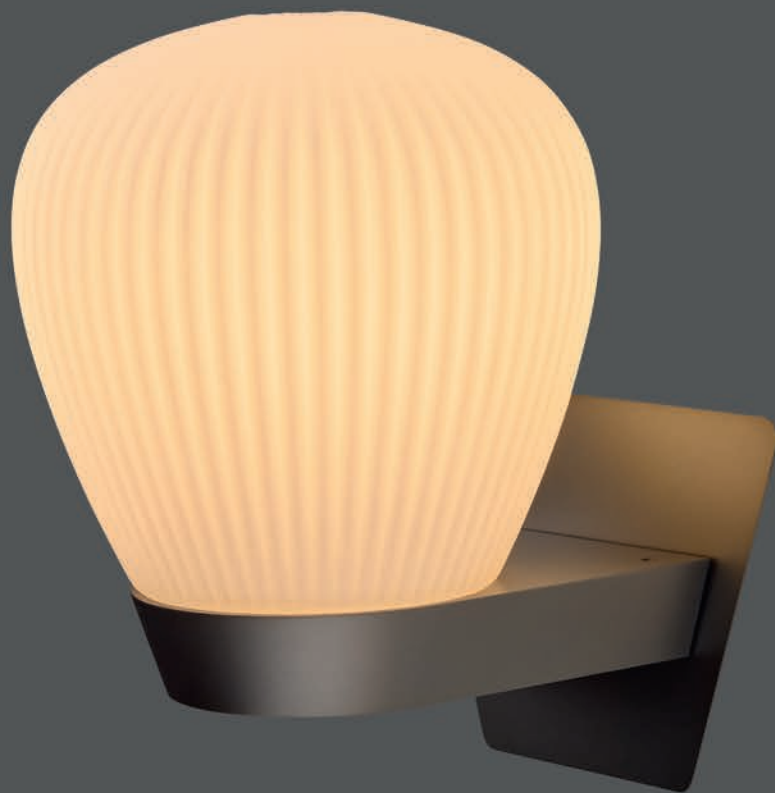

2413-1-62 + 110550-62

plissee d



Im **hauseigenen Werkzeugbau** entstehen die
Serienfertigung unserer Leuchten verwendet
Tiefziehwerkzeug für die Strebe der

Werkzeuge, die später in der
werden. Im Bild wird ein
Plissee-Deckenleuchte gedreht.

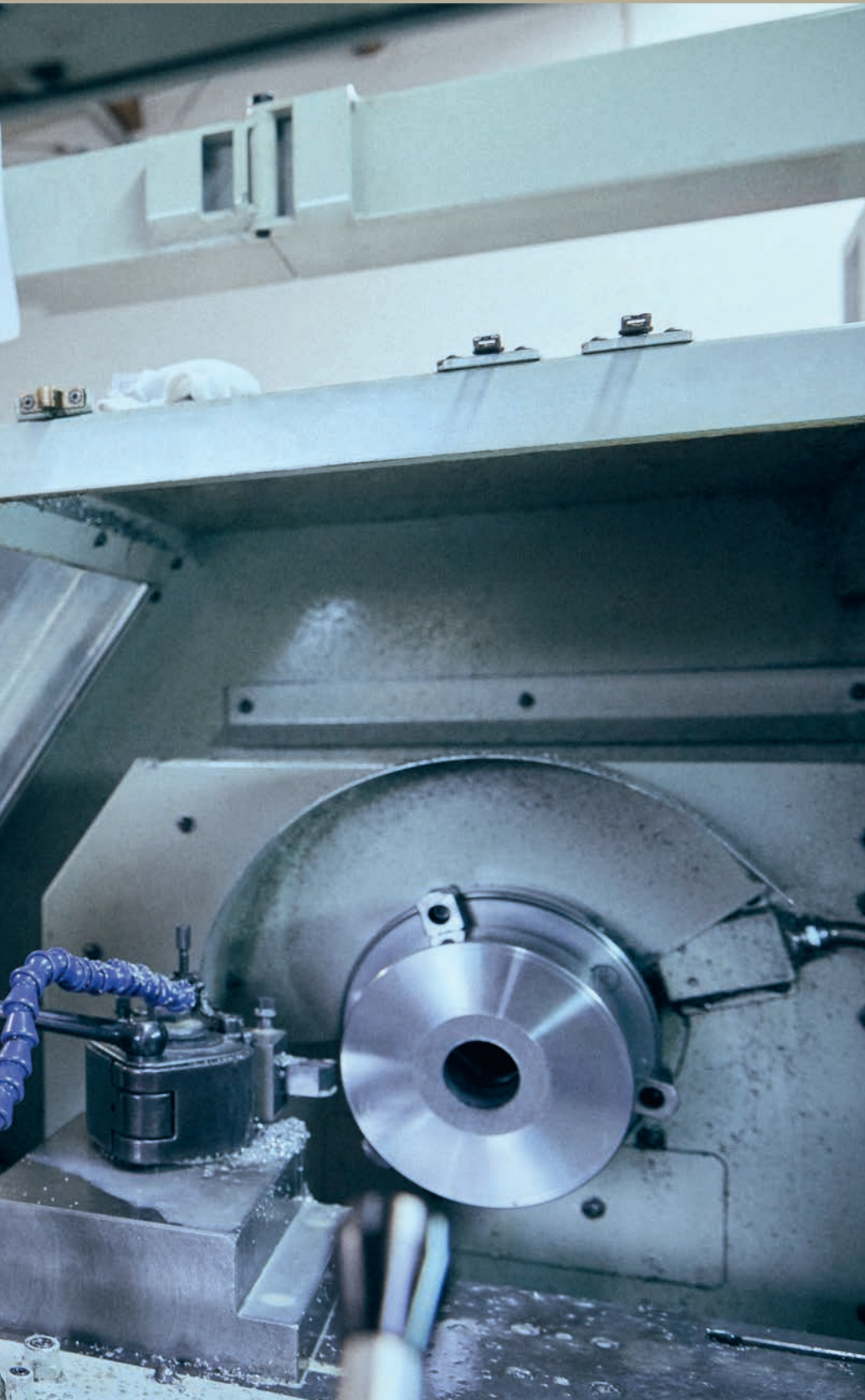



2414-1-79

plissee d

Technische Daten

1x E27 max. 11 Watt
nur LED-Leuchtmittel
230V

Ausführungen

- | | |
|-------------|----------------|
| ● 2414-1-19 | Eloxal Messing |
| ● 2414-1-55 | Schwarz |
| ● 2414-1-62 | Platin |
| ● 2414-1-79 | Aluminium matt |

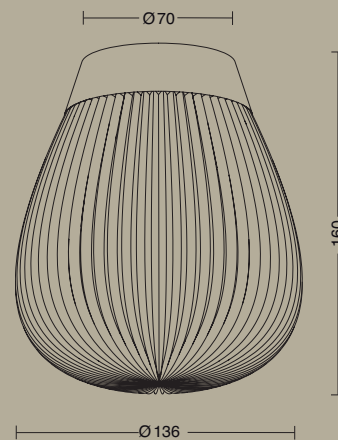

Mundgeblasenes Glas



2414-1-62

liv / golyo

Liv

Milieubild	28-29
Technische Daten	30-31

Golyo

Milieubild	32-33
Technische Daten	34-35



5320-1-62 + GL51-23





5320-1-62 + GL51-23

Technische Daten

1x E27 max. 23 Watt
 nur LED-Leuchtmittel
 230V

Ausführungen

- 5320-1-55 Schwarz
- 5320-1-62 Platin
- 5320-1-79 Aluminium matt

Mundgeblasenes Glas

- GL51-23 Opal matt

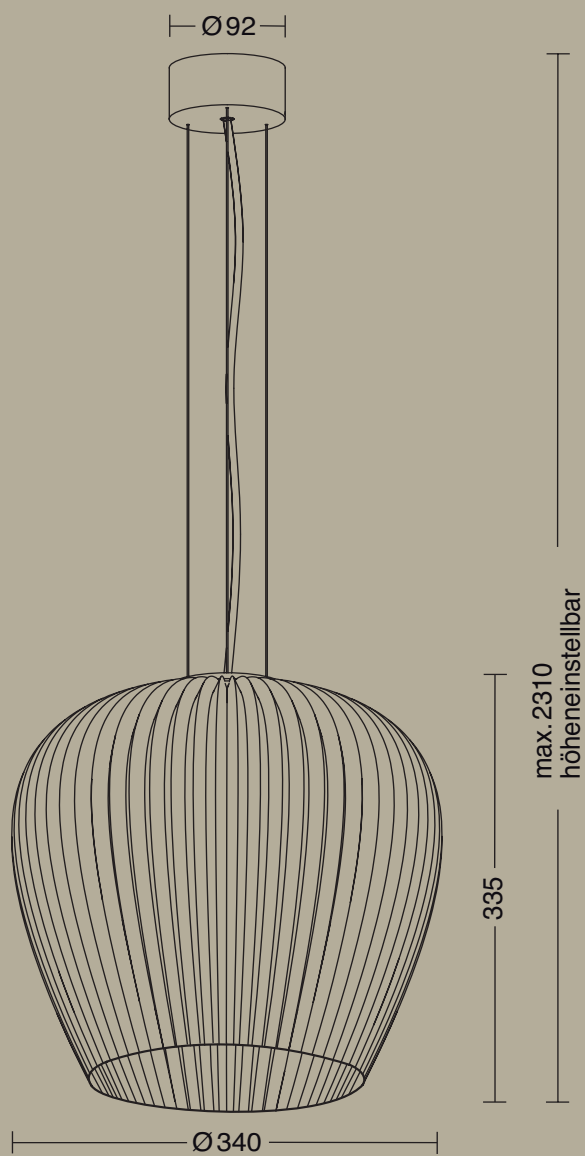

golyo



5320-1-62 + GL50-23



golyo

Technische Daten

1x E27 max. 23 Watt
nur LED-Leuchtmittel
230V

Ausführungen

- 5320-1-55 Schwarz
- 5320-1-62 Platin
- 5320-1-79 Aluminium matt

Mundgeblasenes Glas

- GL50-23 Opal matt

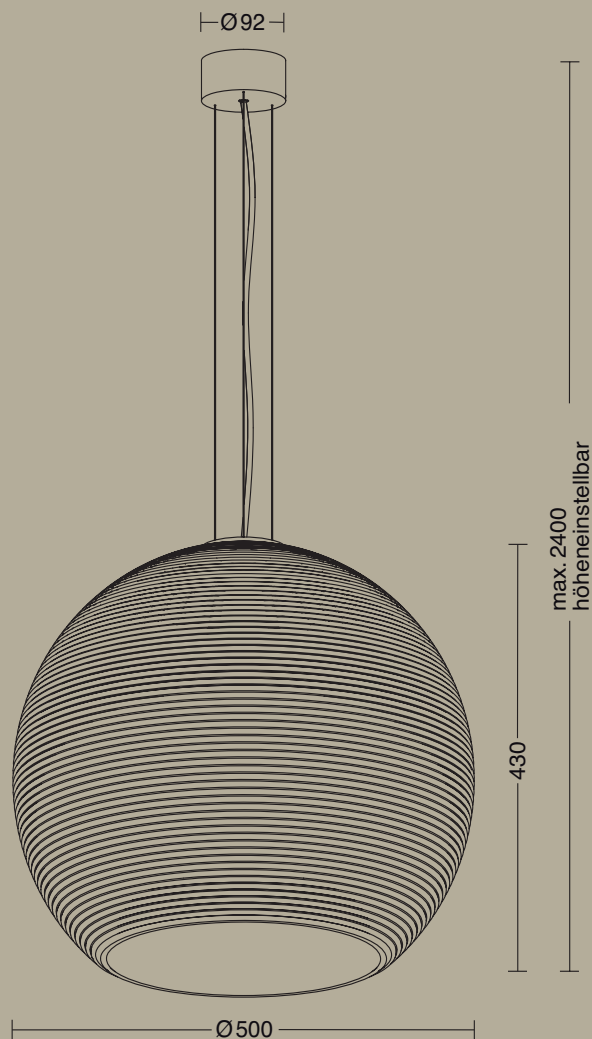

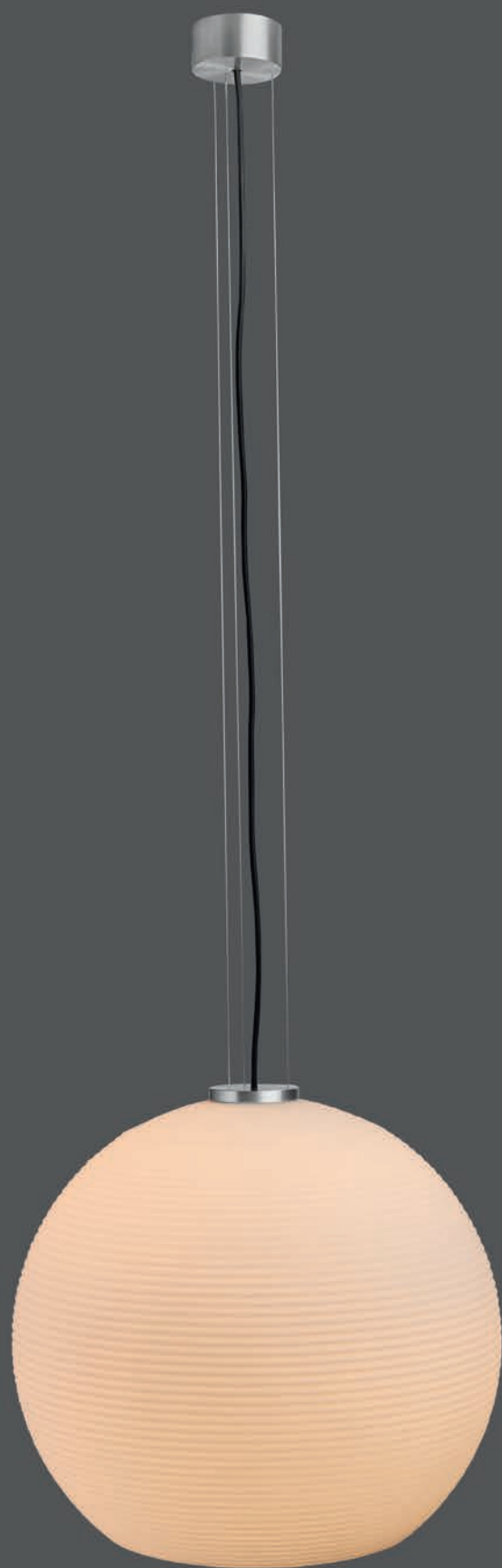

5320-1-79 + GL50-23

fidelio

Milieubild	38-39
Bestandteile	40-41
Mögliche Varianten	42
Produktbeispiel	43
Technische Daten Cristallux	44-45
Technische Daten Glas	46-47
Technische Daten Schirm	48-49

fidelio



2404-4-55 + GL24-100-23



fidelio

Stellen Sie sich Ihre Fidelio-Stehleuchte by Holtkötter individuell zusammen.



Wählen Sie zuerst einen von fünf Leuchtkörpern aus:

Ausführungen

- 2404-4-19 Eloxal Messing
- 2404-4-55 Schwarz
- 2404-4-59 Schwarz / Eloxal Messing
- 2404-4-62 Platin
- 2404-4-79 Aluminium matt

Im Anschluss wählen Sie bitte die Art und Größe der Bestückung aus. Diese kann vollständig aus Cristallux, Glas oder Chintz bestehen, jedoch auch gemischt werden - Übersicht der möglichen Varianten: s. Seite 42

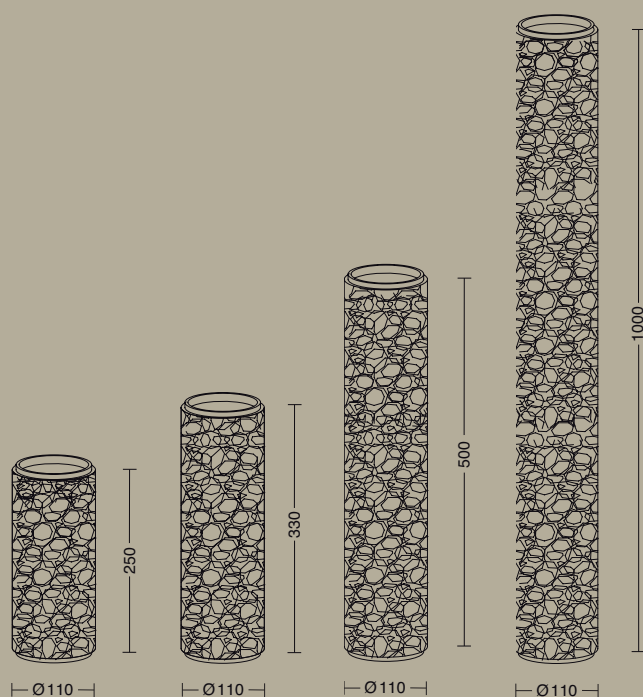

Ausführungen Cristallux

- CR24-25-10 250mm Cristallux
- CR24-33-10 330mm Cristallux
- CR24-50-10 500mm Cristallux
- CR24-100-10 1000mm Cristallux

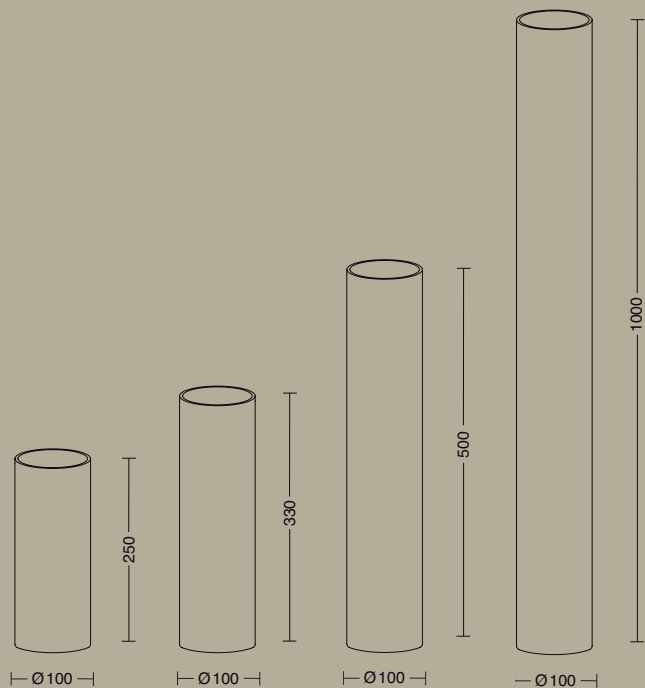

Ausführungen Glas

● GL24-25-23	250mm	Opal matt
● GL24-33-23	330mm	Opal matt
● GL24-50-23	500mm	Opal matt
● GL24-100-23	1000mm	Opal matt

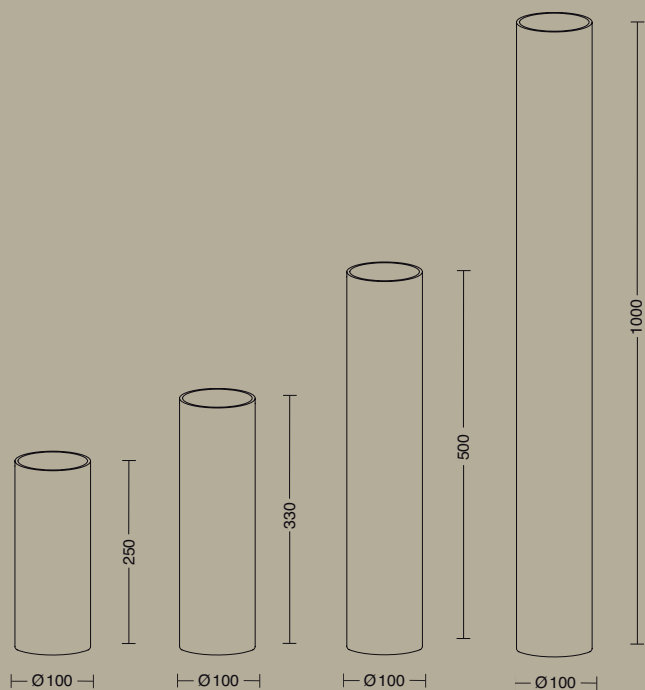

Ausführungen Chintz-Schirme

250mm

● 740-25-12	Hellgrau
● 740-25-4	Champagner
● 740-25-41	Sand
● 740-25-42	Taupe
● 740-25-55	Schwarz
● 740-25-7	Weiß

330mm

● 740-33-12	Hellgrau
● 740-33-4	Champagner
● 740-33-41	Sand
● 740-33-42	Taupe
● 740-33-55	Schwarz
● 740-33-7	Weiß

500mm

● 740-50-12	Hellgrau
● 740-50-4	Champagner
● 740-50-41	Sand
● 740-50-42	Taupe
● 740-50-55	Schwarz
● 740-50-7	Weiß

1000mm

● 740-100-12	Hellgrau
● 740-100-4	Champagner
● 740-100-41	Sand
● 740-100-42	Taupe
● 740-100-55	Schwarz
● 740-100-7	Weiß

fidelio

Wählen Sie bitte die Größe der Bestückung je nach Wunsch.
Die folgenden Teilungen sind möglich:

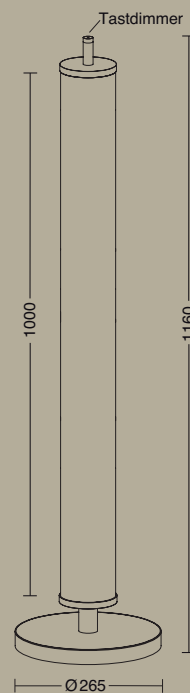
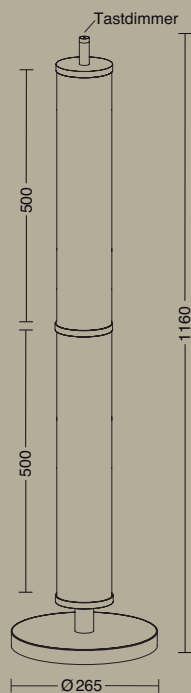
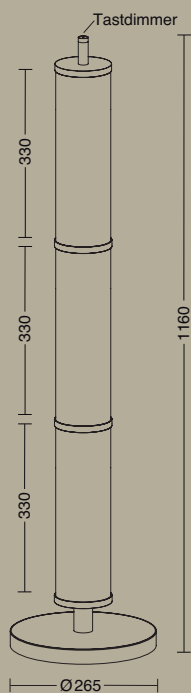
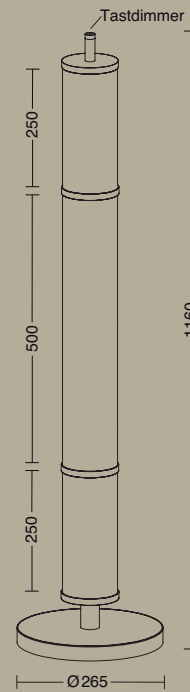
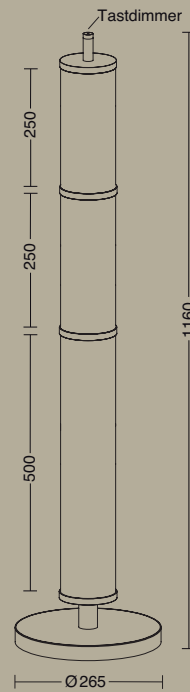
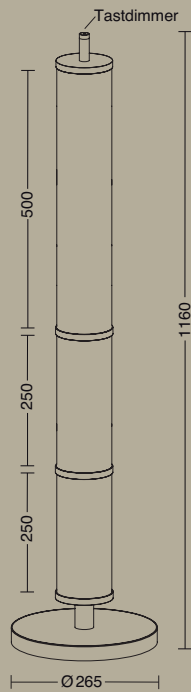
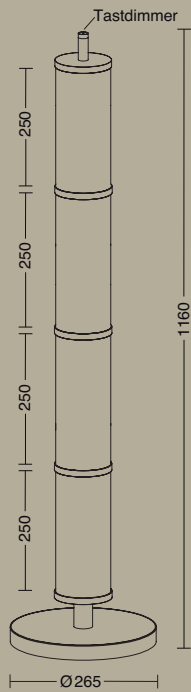

Beispiel: Leuchte in der Oberfläche Schwarz (2404-4-55) + Schirm 250mm in Schwarz (740-25-55) + Cristallux 500mm (CR24-50-10) + Glas 250mm (GL24-25-23)

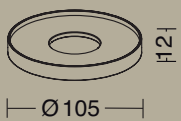
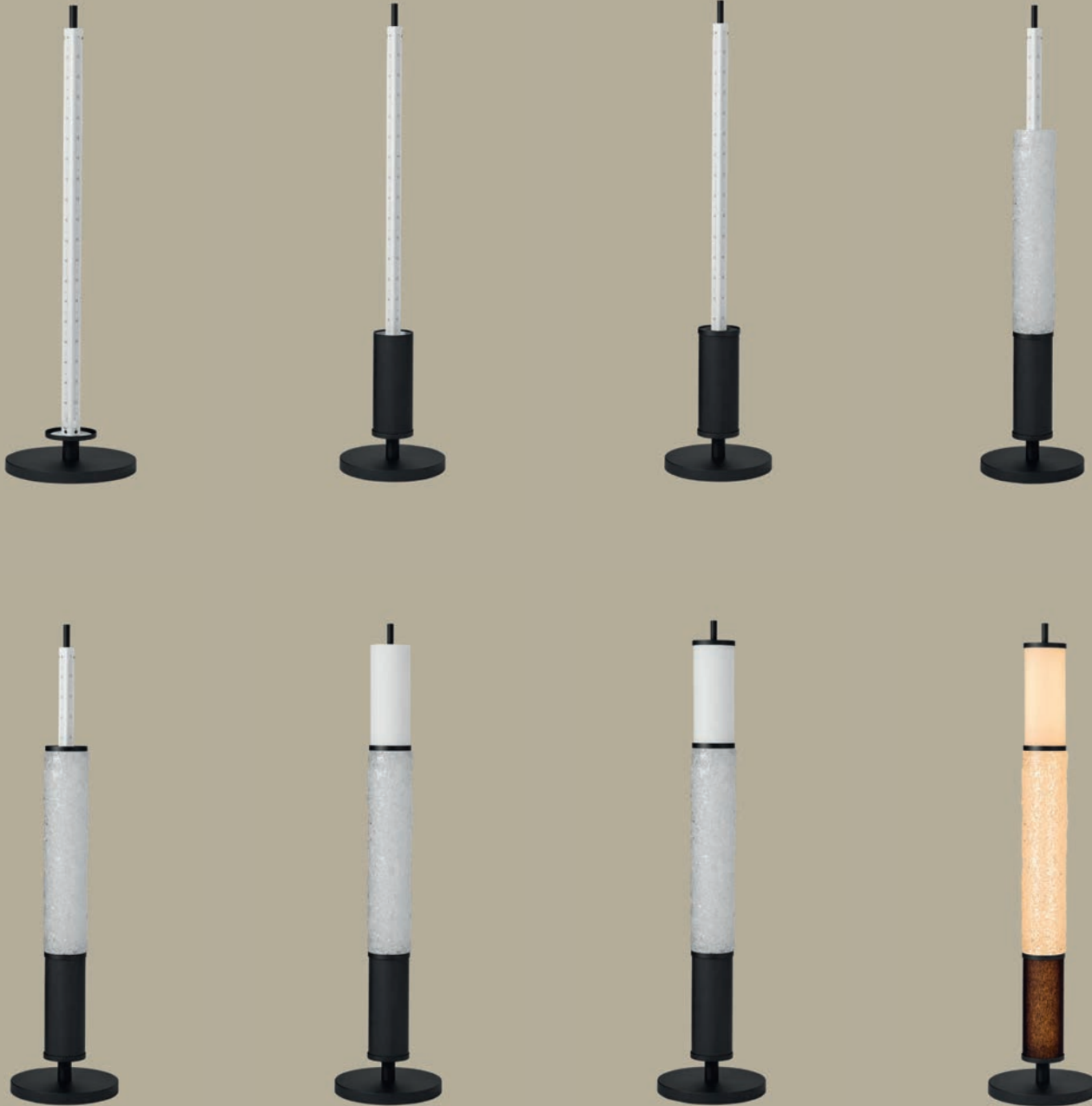

Je nach Aufteilung der Bestückungen liegen die Ringe in der gewählten Oberfläche der Lieferung bei.

fidelio cristallux

Stellen Sie sich Ihre FIDELIO-Leuchte by Holzkötter individuell zusammen.

Cristallux ist in vier Höhen erhältlich. Entweder besteht die Leuchte vollständig aus Cristallux oder wird mit Glas und/oder Schirm kombiniert.

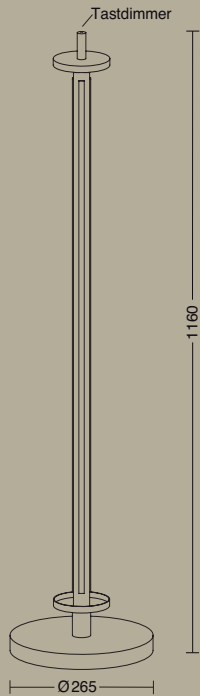

Technische Daten

4x LED
27W - NV-LED
1800 Lumen
2700 Kelvin
CRI > 90
Dimmer

Ausführungen

● 2404-4-19	Eloxal Messing
● 2404-4-55	Schwarz
● 2404-4-59	Schwarz / Eloxal Messing
● 2404-4-62	Platin
● 2404-4-79	Aluminium matt



Ausführungen

● CR24-25-10	250mm	Cristallux
● CR24-33-10	330mm	Cristallux
● CR24-50-10	500mm	Cristallux
● CR24-100-10	1000mm	Cristallux

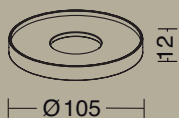

Je nach Aufteilung der Bestückungen liegen die Ringe der Lieferung bei.

CR24-50-10 500mm

CR24-25-10 250mm

CR24-25-10 250mm

2404-4-55 Schwarz



fidelio glas

Stellen Sie sich Ihre FIDELIO-Leuchte by Holzkötter individuell zusammen.

Die Gläser sind in vier Höhen erhältlich. Entweder besteht die Leuchte vollständig aus Glas oder wird mit Cristallux und/oder Schirm kombiniert.

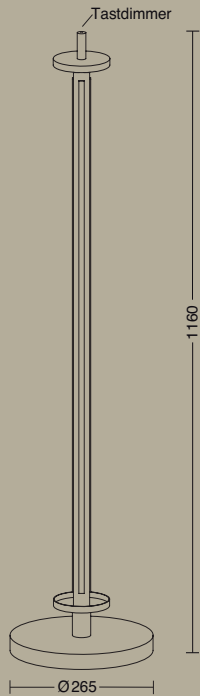

Technische Daten

4x LED
27W - NV-LED
1800 Lumen
2700 Kelvin
CRI > 90
Dimmer

Ausführungen

● 2404-4-19	Eloxal Messing
● 2404-4-55	Schwarz
● 2404-4-59	Schwarz / Eloxal Messing
● 2404-4-62	Platin
● 2404-4-79	Aluminium matt

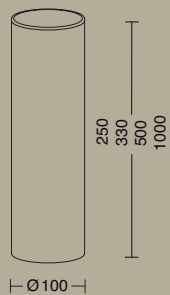

Ausführungen

● GL24-25-23	250mm	Opal matt
● GL24-33-23	330mm	Opal matt
● GL24-50-23	500mm	Opal matt
● GL24-100-23	1000mm	Opal matt

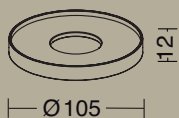

Je nach Aufteilung der Bestückungen liegen die Ringe der Lieferung bei.

GL24-25-23 250mm

GL24-50-23 500mm

GL24-25-23 250mm

2404-4-19
Eloxal Messing

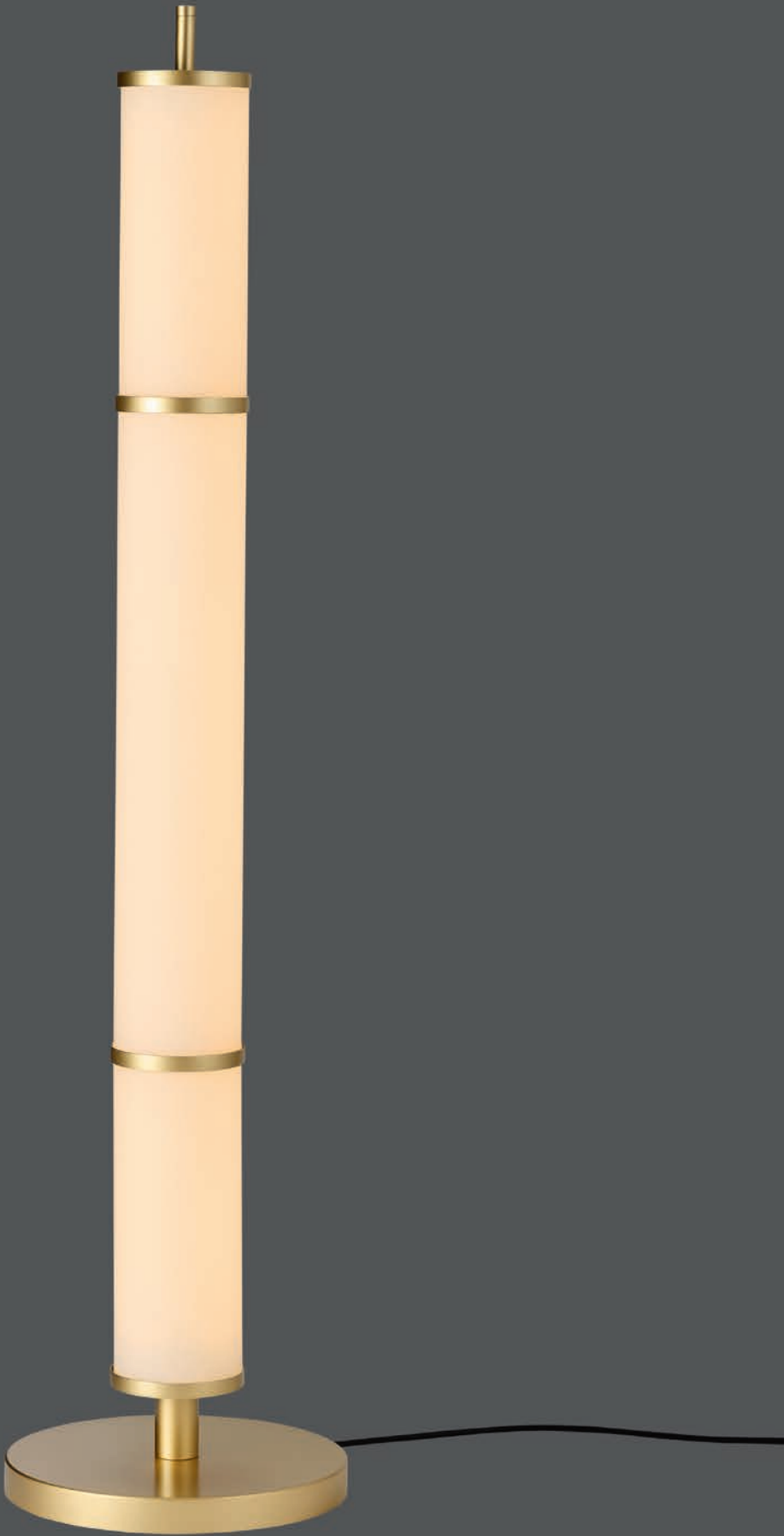

fidelio schirm

Stellen Sie sich Ihre FIDELIO-Leuchte by Holzkötter individuell zusammen.

Die Schirme sind in vier Höhen erhältlich. Entweder besteht die Leuchte vollständig aus Schirm oder wird mit Cristallux und/oder Glas kombiniert.

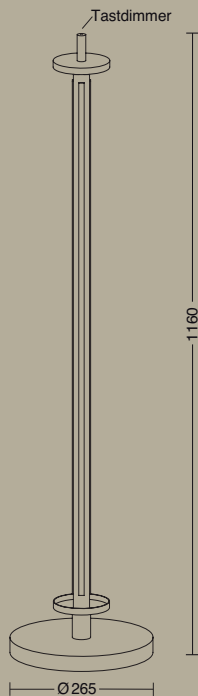

Technische Daten

4x LED
 27W - NV-LED
 1800 Lumen
 2700 Kelvin
 CRI > 90
 Dimmer

Ausführungen

- | | |
|-------------|--------------------------|
| ● 2404-4-19 | Eloxal Messing |
| ● 2404-4-55 | Schwarz |
| ● 2404-4-59 | Schwarz / Eloxal Messing |
| ● 2404-4-62 | Platin |
| ● 2404-4-79 | Aluminium matt |

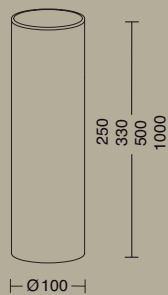

Ausführungen Chintz-Schirme 250mm

- | | |
|-------------|------------|
| ● 740-25-12 | Hellgrau |
| ● 740-25-4 | Champagner |
| ● 740-25-41 | Sand |
| ● 740-25-42 | Taupe |
| ● 740-25-55 | Schwarz |
| ● 740-25-7 | Weiß |

Ausführungen Chintz-Schirme 330mm

- | | |
|-------------|------------|
| ● 740-33-12 | Hellgrau |
| ● 740-33-4 | Champagner |
| ● 740-33-41 | Sand |
| ● 740-33-42 | Taupe |
| ● 740-33-55 | Schwarz |
| ● 740-33-7 | Weiß |

Ausführungen Chintz-Schirme 500 mm

- | | |
|-------------|------------|
| ● 740-50-12 | Hellgrau |
| ● 740-50-4 | Champagner |
| ● 740-50-41 | Sand |
| ● 740-50-42 | Taupe |
| ● 740-50-55 | Schwarz |
| ● 740-50-7 | Weiß |

Ausführungen Chintz-Schirme 1000mm

- | | |
|--------------|------------|
| ● 740-100-12 | Hellgrau |
| ● 740-100-4 | Champagner |
| ● 740-100-41 | Sand |
| ● 740-100-42 | Taupe |
| ● 740-100-55 | Schwarz |
| ● 740-100-7 | Weiß |

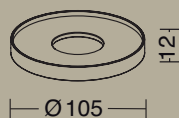

Je nach Aufteilung der Bestückungen liegen die Ringe der Lieferung bei.

740-25-4 250mm

740-25-55 250mm

740-25-4 250mm

740-25-55 250mm

2404-4-55 Schwarz

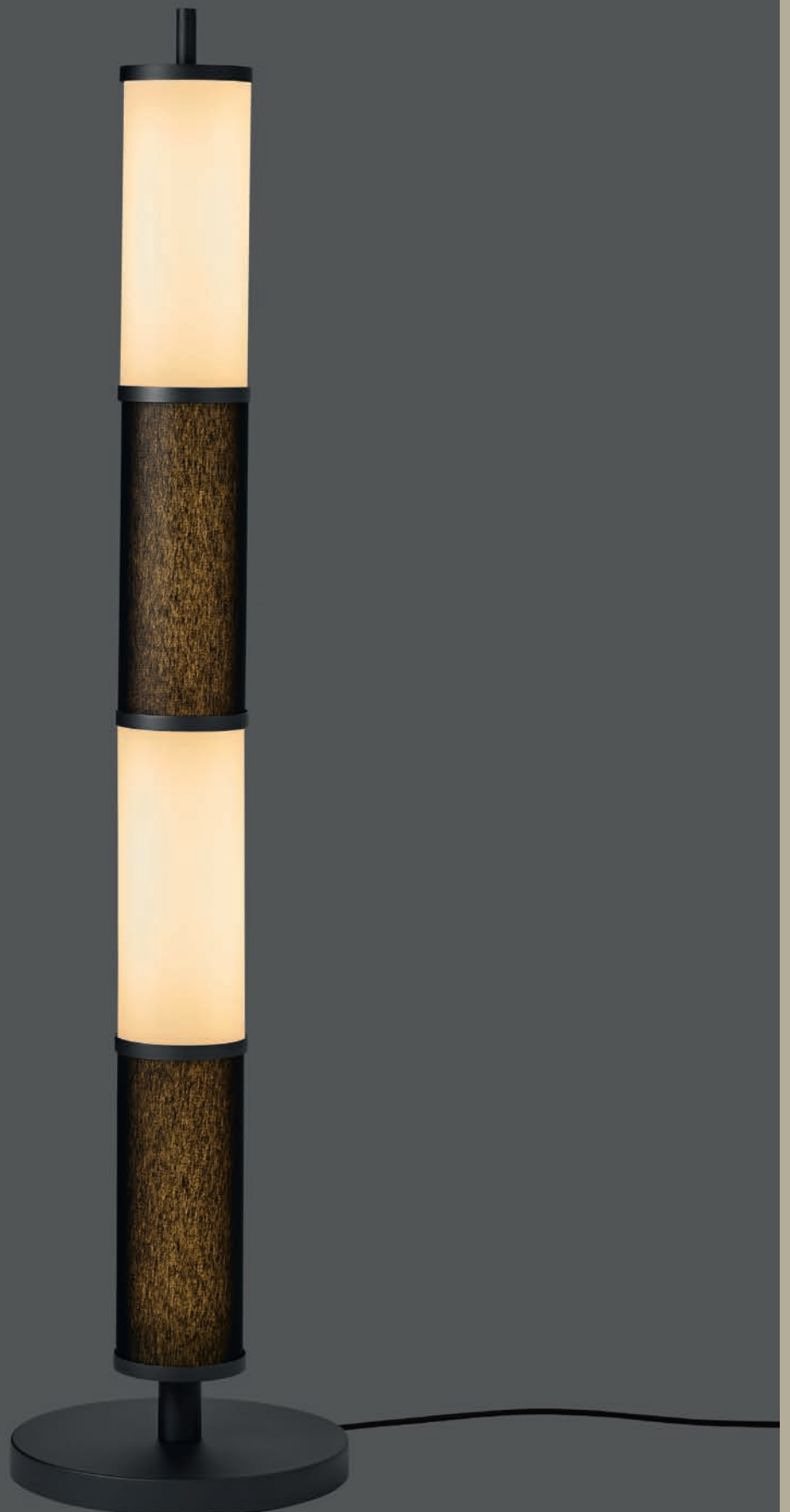

favor

Favor S

Milieubild	52-53
Technische Daten	54-55

Favor 1-flammig

Technische Daten	56-57
------------------	-------

Favor 2-flammig

Technische Daten	58-59
------------------	-------

Favor 3-flammig

Technische Daten	60-61
------------------	-------

favor s



2050-1-59





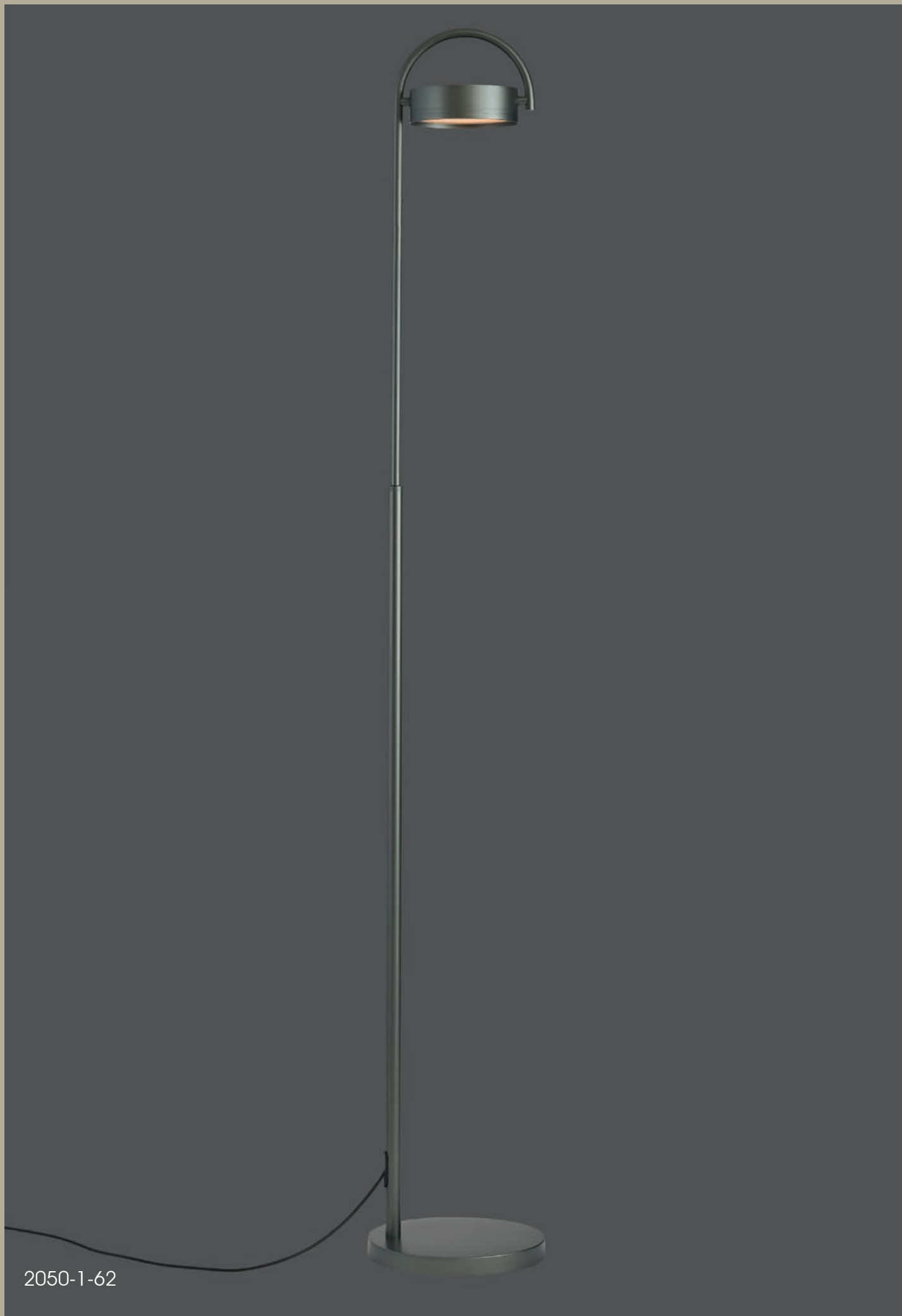

2050-1-62

favor s

Technische Daten

1x LED
10W - NV-LED
1400 Lumen
2200 - 2850 Kelvin - DIM TO WARM
CRI >90
Dimmer

Ausführungen

- 2050-1-55 Schwarz
- 2050-1-59 Schwarz / Eloxal Messing
- 2050-1-62 Platin
- 2050-1-79 Aluminium matt

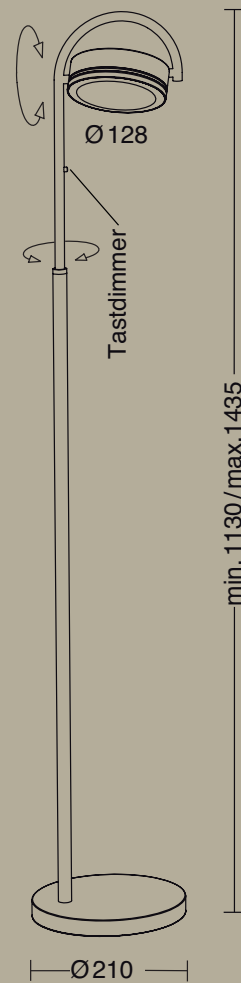

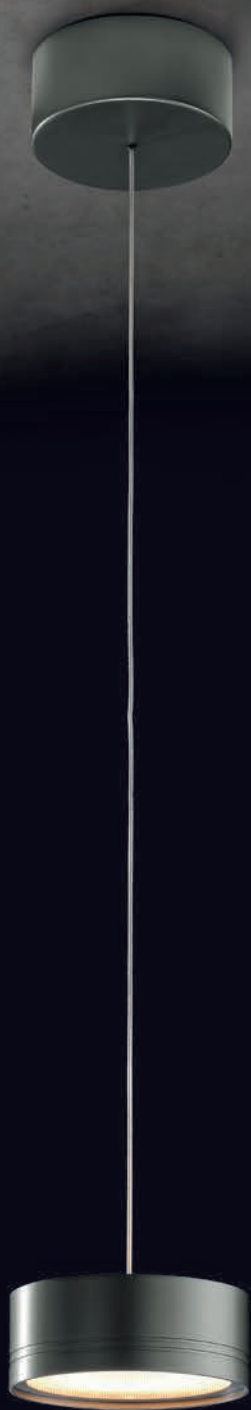

2051-1-62

Technische Daten

1x LED
19W - NV-LED
2750 Lumen
2200 - 2850 Kelvin - DIM TO WARM
CRI >90
Dimmbar

Ausführungen

- 2051-1-55 Schwarz
- 2051-1-62 Platin
- 2051-1-79 Aluminium matt

Sonder-Litzenlängen sind auf Anfrage als Sonderanfertigung gegen einen Aufpreis möglich.

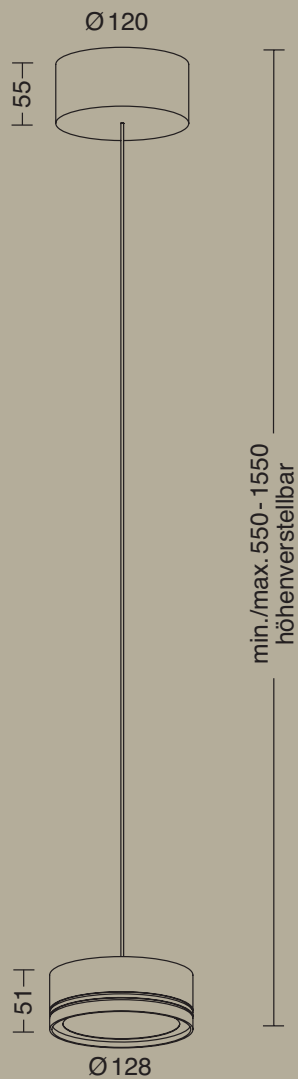

favor

Technische Daten

2x LED
2x 19W - NV-LED
5500 Lumen
2200 - 2850 Kelvin - DIM TO WARM
CRI >90
Dimmbar

Ausführungen

- 2052-2-55 Schwarz
- 2052-2-62 Platin
- 2052-2-79 Aluminium matt

Sonder-Litzenlängen sind auf Anfrage als Sonderanfertigung gegen einen Aufpreis möglich.

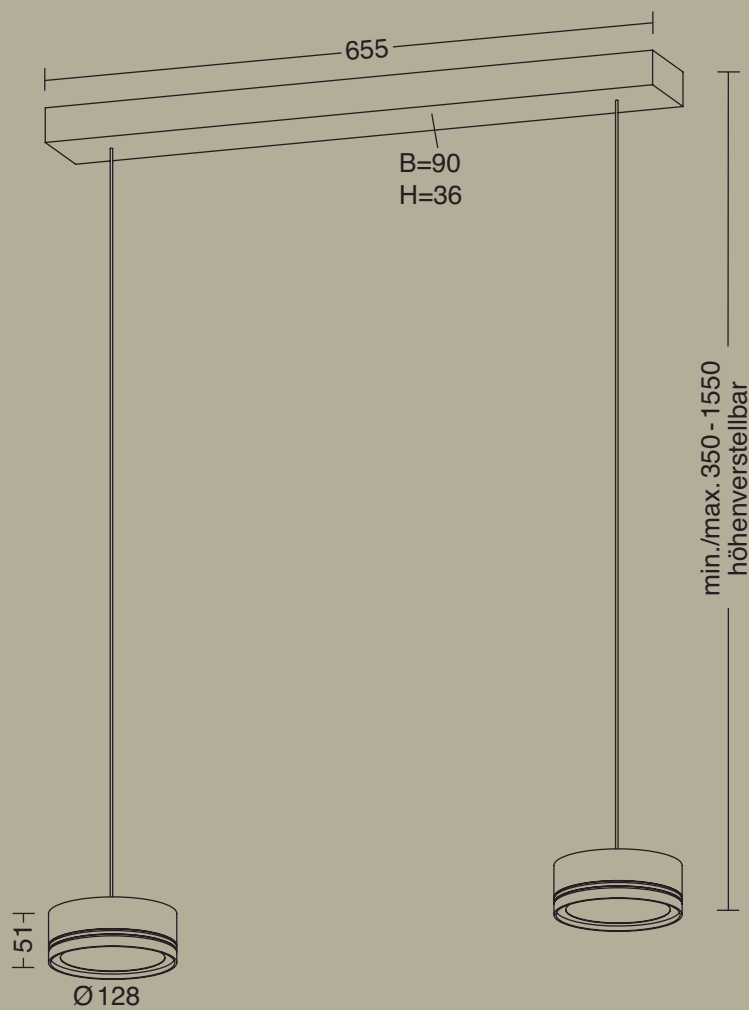



2052-2-62

favor

Technische Daten

3x LED
3x 19W - NV-LED
8250 Lumen
2200 - 2850 Kelvin - DIM TO WARM
CRI >90
Dimmbar

Ausführungen

- 2053-3-55 Schwarz
- 2053-3-62 Platin
- 2053-3-79 Aluminium matt

Sonder-Litzenlängen sind auf Anfrage als Sonderanfertigung gegen einen Aufpreis möglich.

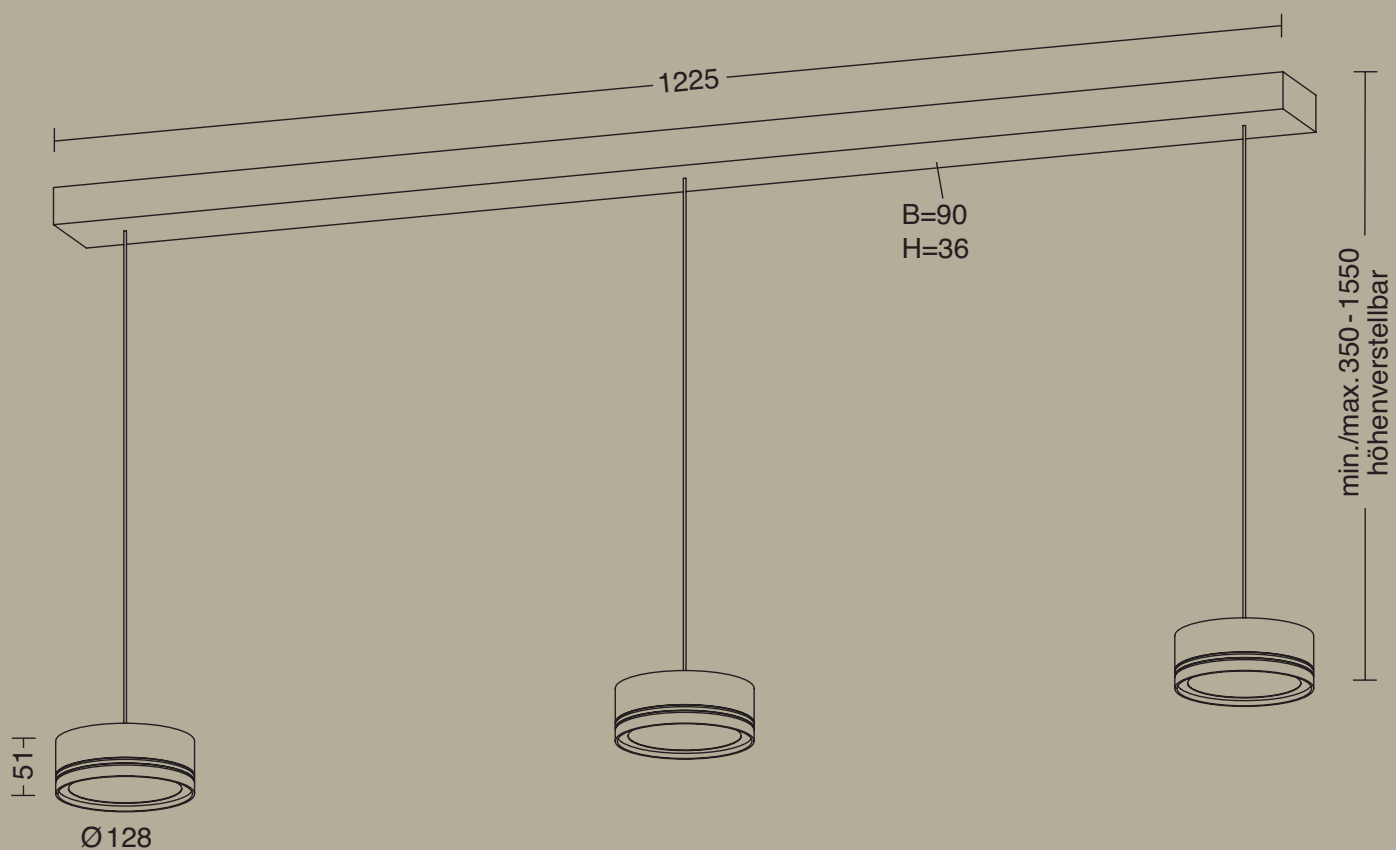



2053-3-79

naxos

Milieubild	64-65
Produktionsbild	66-67
Technische Daten	68-69

naxos



9940-1-59



naxos

Punktschweißen: Im Bild werden drei Bolzen auf den **Naxos-Reflektor** geschweißt. Dies ermöglicht eine sichere Verschraubung der LED-Platinen und gewährleistet deren einfache Austauschbarkeit.



naxos

Technische Daten

1x LED
71W - NV-LED
8800 Lumen
2200 - 2850 Kelvin - DIM TO WARM
CRI >90
Dimmer

Ausführungen

- | | |
|-------------|--------------------------|
| ● 9940-1-19 | Eloxal Messing |
| ● 9940-1-33 | Bronze |
| ● 9940-1-55 | Schwarz |
| ● 9940-1-59 | Schwarz / Eloxal Messing |
| ● 9940-1-62 | Platin |
| ● 9940-1-79 | Aluminium matt |
| ● 9940-1-8 | Weiß |

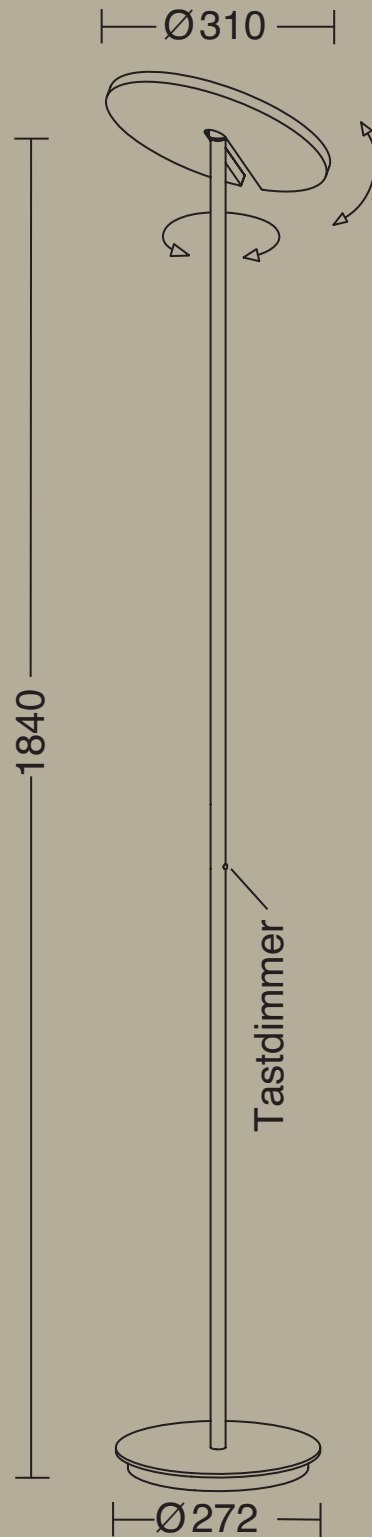



9940-1-33

janus

Janus H

Milieubild

72-73

Technische Daten

74-75

Janus E

Technische Daten

76

Janus K

Technische Daten

77

janus h



2183-2-79



janus h

Technische Daten

2x LED
2x 18W - NV-LED
5400 Lumen
2200 - 2850 Kelvin - DIM TO WARM
CRI >90
Dimmer

Ausführungen

- 2183-2-55 Schwarz
- 2183-2-59 Schwarz / Eloxal Messing
- 2183-2-79 Aluminium matt

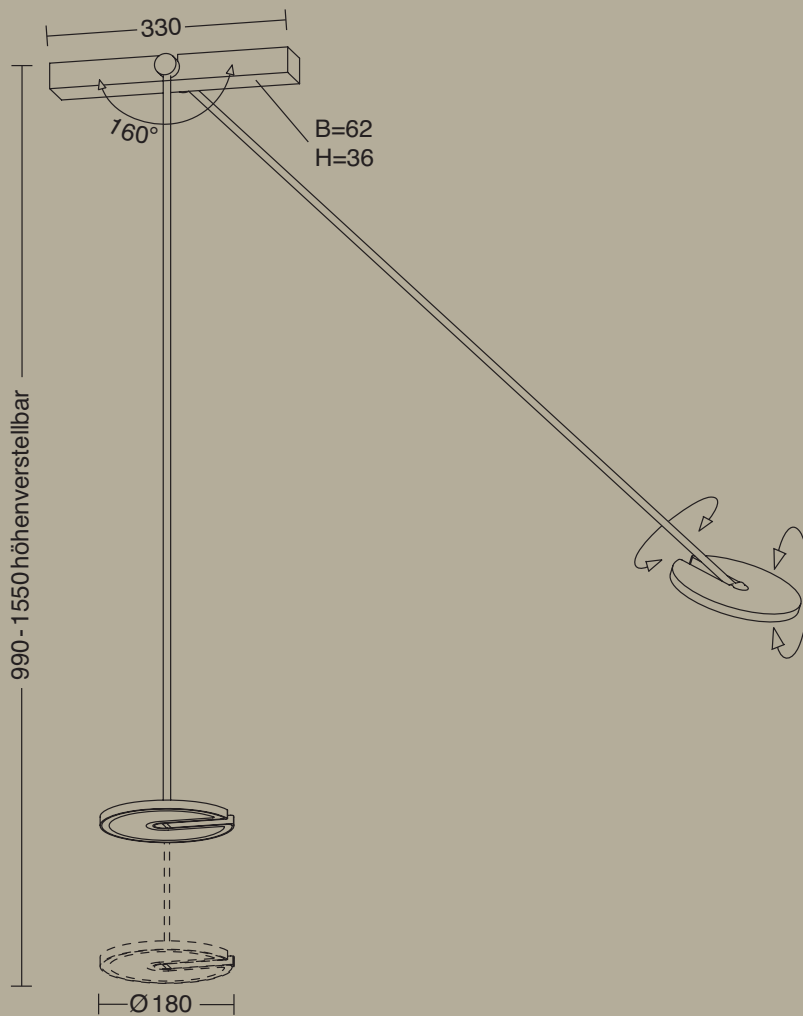



2183-2-55

janus e

Technische Daten

1x LED
18W - NV-LED
2700 Lumen
2200 - 2850 Kelvin - DIM TO WARM
CRI >90
Dimmer

Ausführungen

- 2171-1-55 Schwarz
- 2171-1-59 Schwarz / Eloxal Messing
- 2171-1-79 Aluminium matt

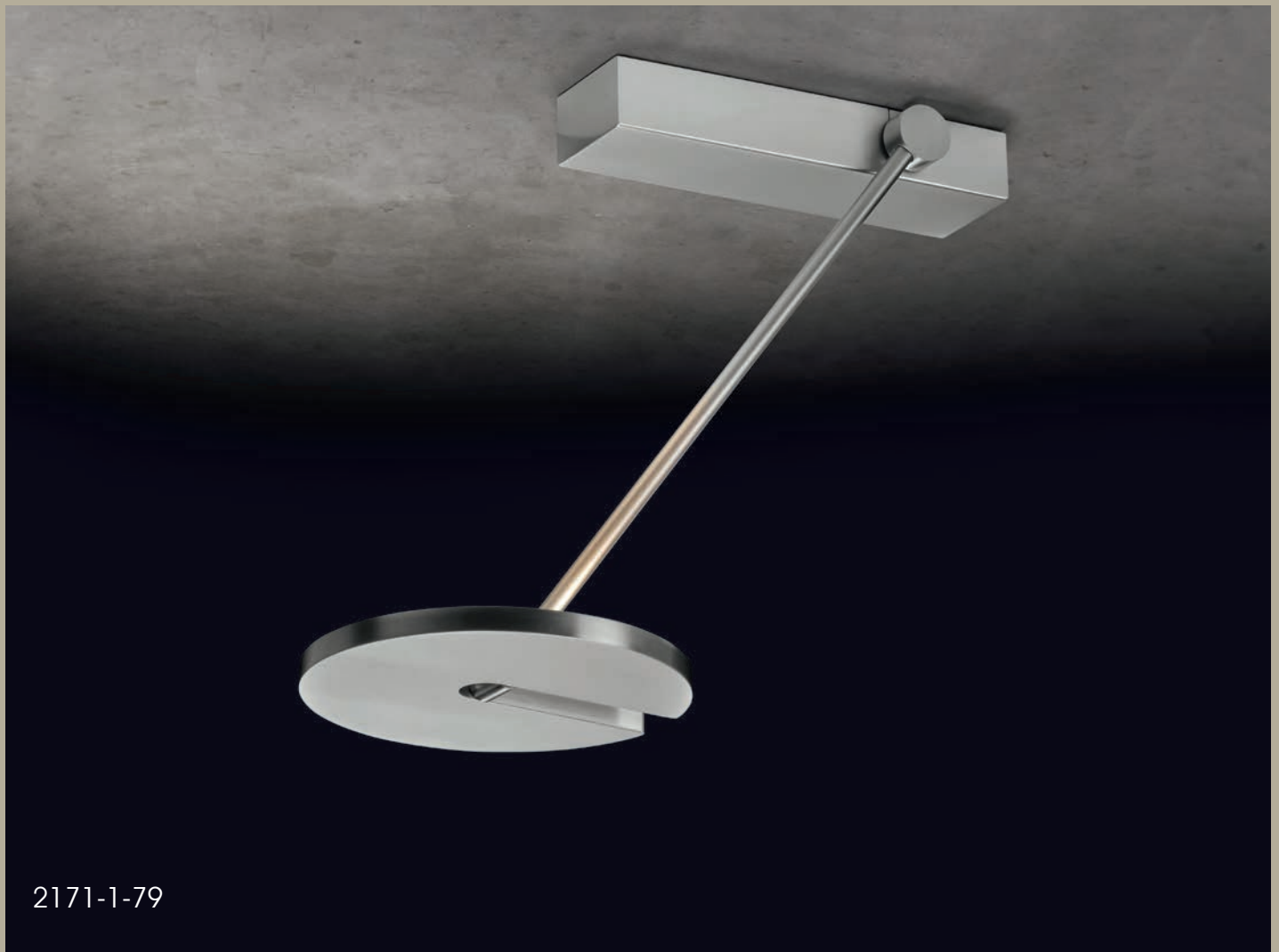
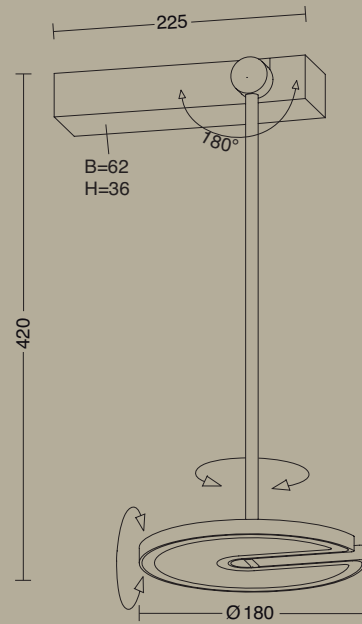

2171-1-79

janus k

Technische Daten

2x LED
2x 18W - NV-LED
5400 Lumen
2200 - 2850 Kelvin - DIM TO WARM
CRI >90
Dimmer

Ausführungen

- 2173-2-55 Schwarz
- 2173-2-59 Schwarz / Eloxad Messing
- 2173-2-79 Aluminium matt

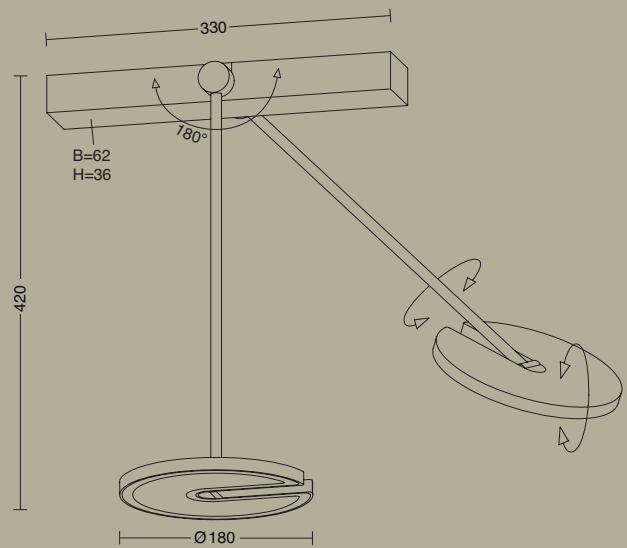

2173-2-59

supernova

SuperNova D/DW + P/PW

Milieubild SuperNova D/DW / P/PW	80-81
Milieubild SuperNova DW	82-83
Technische Daten SuperNova D/DW	84-85
Milieubild SuperNova P/PW	86-87
Technische Daten SuperNova P/PW	88-89

SuperNova S/DTW

Milieubild	90-91
Produktionsbild	92-93
Technische Daten	94-95

Vince S

Technische Daten	96-97
------------------	-------

SuperNova GT / T

Technische Daten SuperNova GT	98-99
Technische Daten SuperNova T	100-101

SuperNova W/WD

Technische Daten SuperNova W	102-103
Technische Daten SuperNova WD	102-103

SuperNova DL / Orbit

Technische Daten SuperNova DL	104
Technische Daten Orbit	105

supernova dw / pw





2130-2-79 / 2131-2-79; 2120-2-79 / 2121-2-79

supernova d/dw





2130-2-62 / 2131-2-62

supernova d/dw

SuperNova D

Technische Daten Innenring

1x LED
60W - NV-LED
7350 Lumen
2700 - 3100 Kelvin - DIM TO WARM
CRI 98
Dimmer

SuperNova D

Technische Daten Außenring

1x LED
38W - NV-LED
4650 Lumen
2700 - 3100 Kelvin - DIM TO WARM
CRI 98
Dimmer

Ausführungen

● 2130-2-19	Eloxal Messing
● 2130-2-55	Schwarz
● 2130-2-62	Platin
● 2130-2-79	Aluminium matt

SuperNova DW

Technische Daten Innenring

1x LED
71W - NV-LED
8800 Lumen
2200 - 2900 Kelvin - DIM TO WARM
CRI >90
Dimmer

SuperNova DW

Technische Daten Außenring

1x LED
40W - NV-LED
5900 Lumen
2200 - 2900 Kelvin - DIM TO WARM
CRI >90
Dimmer

Ausführungen

● 2131-2-19	Eloxal Messing
● 2131-2-55	Schwarz
● 2131-2-62	Platin
● 2131-2-79	Aluminium matt

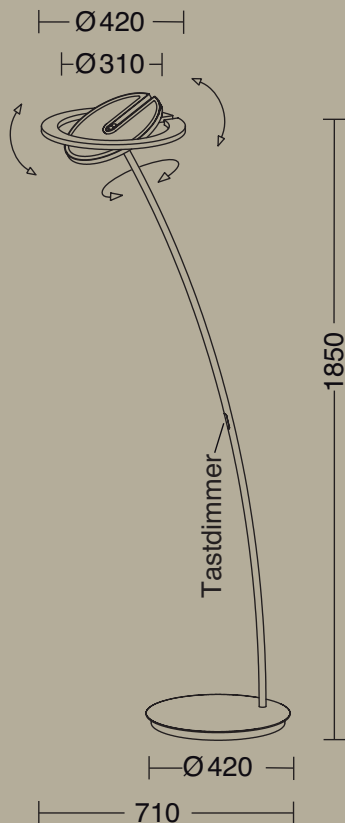



2130-2-55 / 2131-2-55

supernova p/pw



2120-2-62 / 2121-2-62



supernova p/pw

SuperNova P

Technische Daten Innenring

1x LED
33W - NV-LED
3350 Lumen
2700 - 3100 Kelvin - DIM TO WARM
CRI 98
Dimmer

SuperNova P

Technische Daten Außenring

1x LED
31W - NV-LED
3900 Lumen
2700 - 3100 Kelvin - DIM TO WARM
CRI 98
Dimmer

Ausführungen

● 2120-2-19	Eloxal Messing
● 2120-2-55	Schwarz
● 2120-2-62	Platin
● 2120-2-79	Aluminium matt

SuperNova PW

Technische Daten Innenring

1x LED
31W - NV-LED
4250 Lumen
2200 - 2900 Kelvin - DIM TO WARM
CRI >90
Dimmer

SuperNova PW

Technische Daten Außenring

1x LED
29W - NV-LED
4500 Lumen
2200 - 2900 Kelvin - DIM TO WARM
CRI >90
Dimmer

Ausführungen

● 2121-2-19	Eloxal Messing
● 2121-2-55	Schwarz
● 2121-2-62	Platin
● 2121-2-79	Aluminium matt

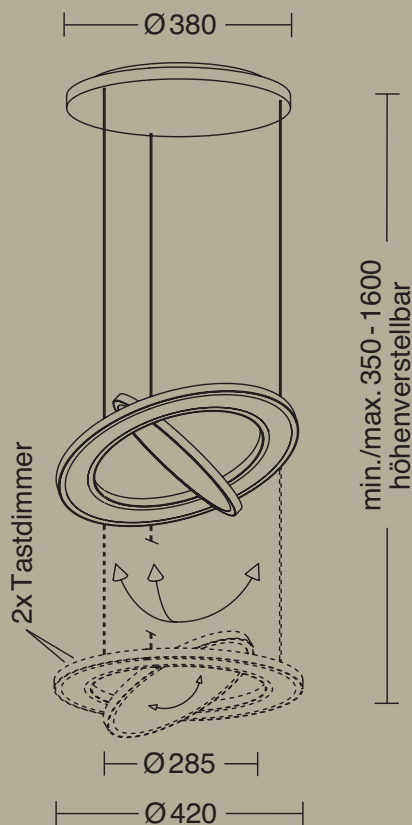

Sonder-Litzenlängen sind auf Anfrage als Sonderanfertigung gegen einen Aufpreis möglich.

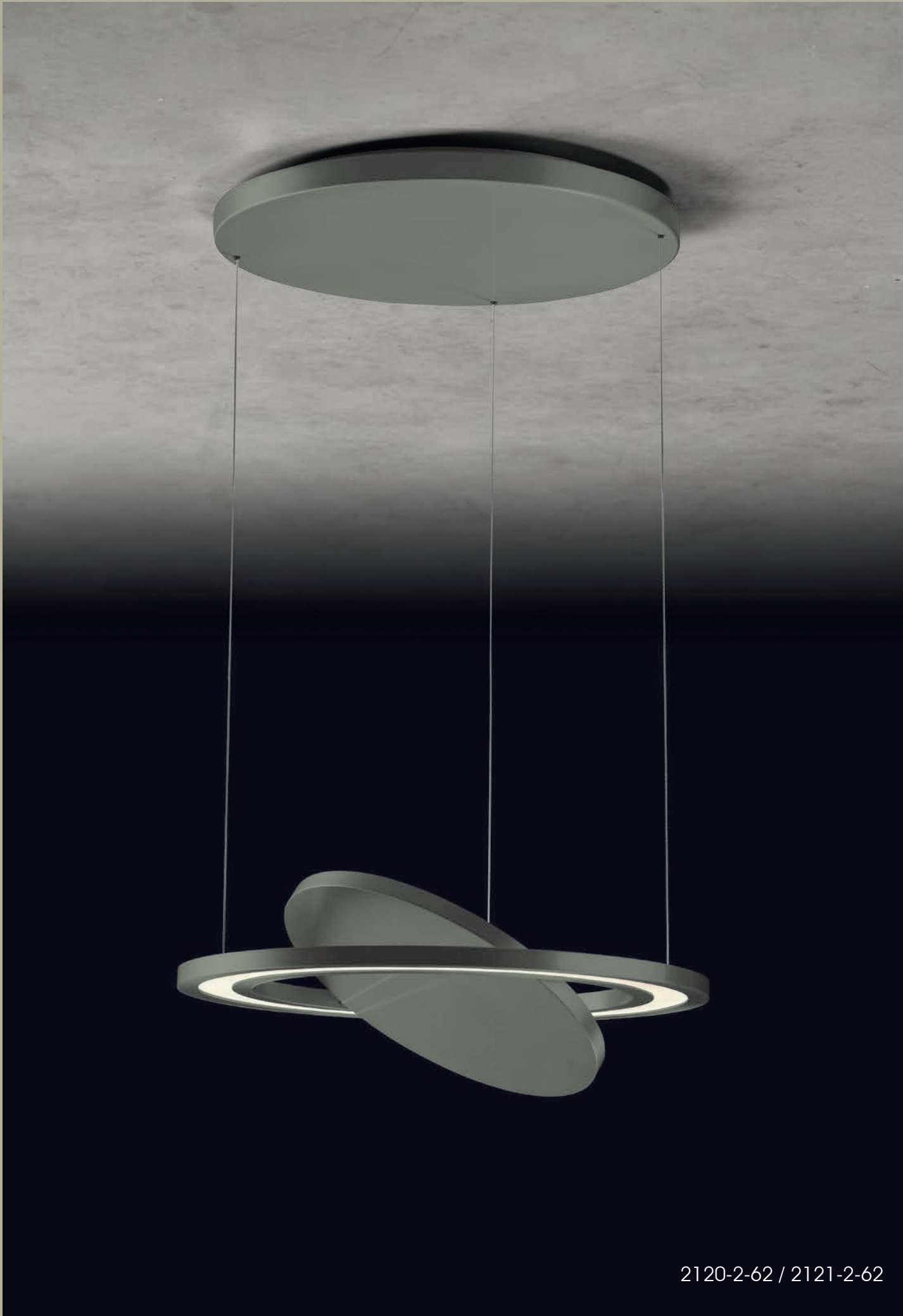

2120-2-62 / 2121-2-62

supernova s / dtw



2145-1-33 / 2155-1-33





Präzises Schneiden mit Wasserstrahltechnik: Mit unserem Wasserstrahler schneiden wir Leuchtenreflektoren aus einer Aluminiumtafel. Der Wasserstrahl, gemischt mit Abrasivpartikeln, schneidet unter Hochdruck das Material präzise und sauber. So entstehen **elegante Reflektoren**, die unseren hohen Qualitätsstandards entsprechen.

supernova s / dtw



Jede einzelne Leuchte wird vor dem Verpacken auf **Funktionalität** und **elektrische Sicherheit** überprüft.



2145-1-59 / 2155-1-59; 2145-1-33 / 2155-1-33

supernova s / dtw

SuperNova S

Technische Daten

1x LED
18W - NV-LED
2600 Lumen
2700 Kelvin
CRI >90
Dimmer

Ausführungen

● 2145-1-19	Eloxal Messing
● 2145-1-33	Bronze
● 2145-1-55	Schwarz
● 2145-1-59	Schwarz / Eloxal Messing
● 2145-1-62	Platin
● 2145-1-79	Aluminium matt
● 2145-1-8	Weiß

SuperNova S DTW

Technische Daten

1x LED
16W - NV-LED
2500 Lumen
2200 - 2850 Kelvin - DIM TO WARM
CRI >90
Dimmer

Ausführungen

● 2155-1-19	Eloxal Messing
● 2155-1-33	Bronze
● 2155-1-55	Schwarz
● 2155-1-59	Schwarz / Eloxal Messing
● 2155-1-62	Platin
● 2155-1-79	Aluminium matt
● 2155-1-8	Weiß

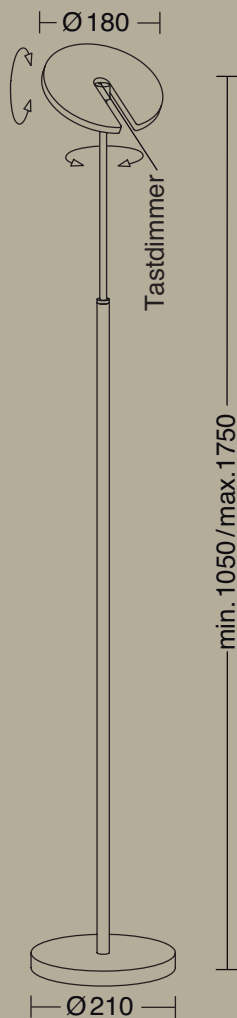



2040-1-33

vince s

Technische Daten

1x LED
16W - NV-LED
2500 Lumen
2200 - 2850 Kelvin - DIM TO WARM
CRI >90
Dimmer

Ausführungen

- | | |
|-------------|--------------------------|
| ● 2040-1-33 | Bronze |
| ● 2040-1-55 | Schwarz |
| ● 2040-1-59 | Schwarz / Eloxal Messing |
| ● 2040-1-62 | Platin |
| ● 2040-1-79 | Aluminium matt |
| ● 2040-1-8 | Weiß |

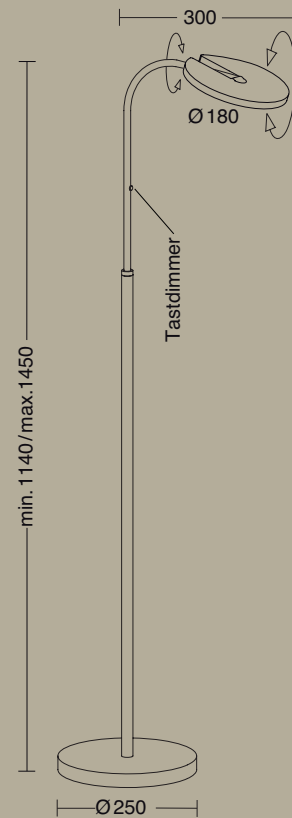

2040-1-79; 2040-1-59; 2040-1-55; 2040-1-8





2190-1-8

supernova gt

Technische Daten

1x LED
16W - NV-LED
2500 Lumen
2200 - 2850 Kelvin - DIM TO WARM
CRI >90
Dimmer

Ausführungen

- | | |
|-------------|--------------------------|
| ● 2190-1-55 | Schwarz |
| ● 2190-1-59 | Schwarz / Eloxal Messing |
| ● 2190-1-62 | Platin |
| ● 2190-1-79 | Aluminium matt |
| ● 2190-1-8 | Weiß |

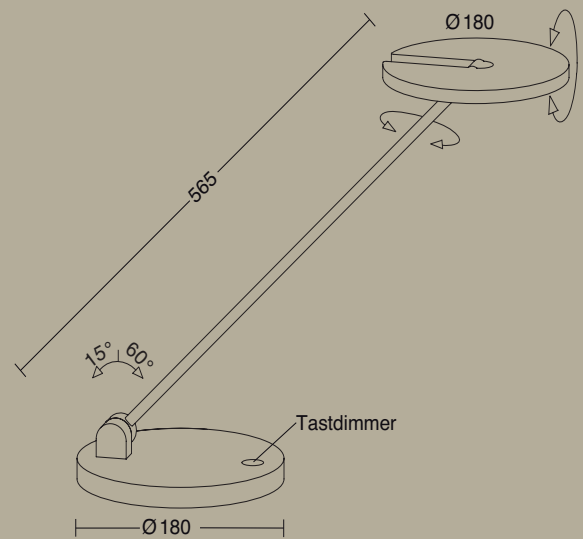

2190-1-59

supernova t

Technische Daten

1x LED
18W - NV-LED
2600 Lumen
2700 Kelvin
CRI >90
Dimmer

Ausführungen

- | | |
|-------------|----------------|
| ● 2146-1-19 | Eloxal Messing |
| ● 2146-1-55 | Schwarz |
| ● 2146-1-62 | Platin |
| ● 2146-1-79 | Aluminium matt |
| ● 2146-1-8 | Weiß |

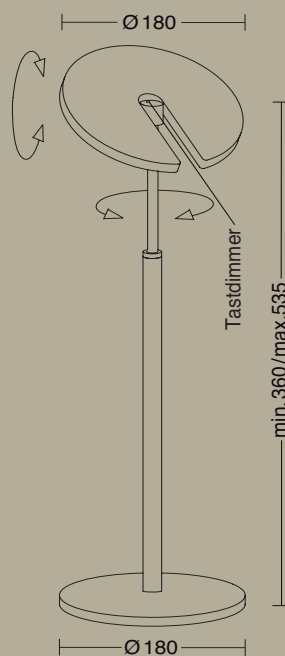

2146-1-79



2146-1-55



2140-1-62; 2141-1-79



2141-1-19

supernova w / wd

Technische Daten SuperNova W

1x LED
18W - NV-LED
2600 Lumen
2700 Kelvin
CRI >90
Dimmbar

Ausführungen

- 2140-1-19 Eloxal Messing
- 2140-1-55 Schwarz
- 2140-1-62 Platin
- 2140-1-79 Aluminium matt

Technische Daten SuperNova WD

1x LED
18W - NV-LED
2600 Lumen
2700 Kelvin
CRI >90
Dimmer

Ausführungen

- 2141-1-19 Eloxal Messing
- 2141-1-55 Schwarz
- 2141-1-62 Platin
- 2141-1-79 Aluminium matt

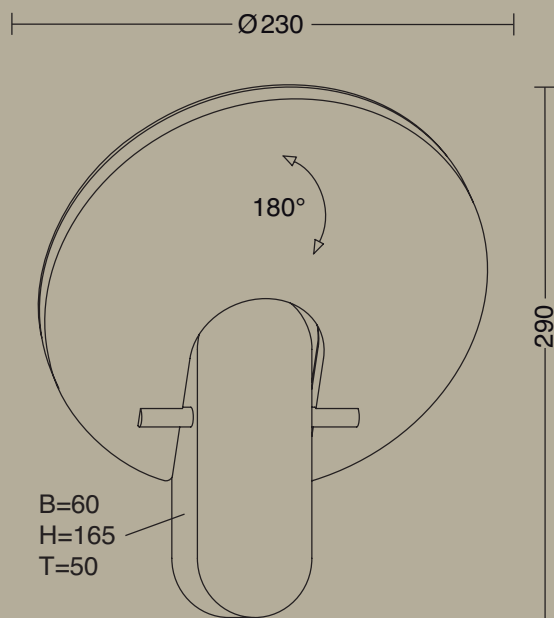

Ausladung min. 50/max. 245

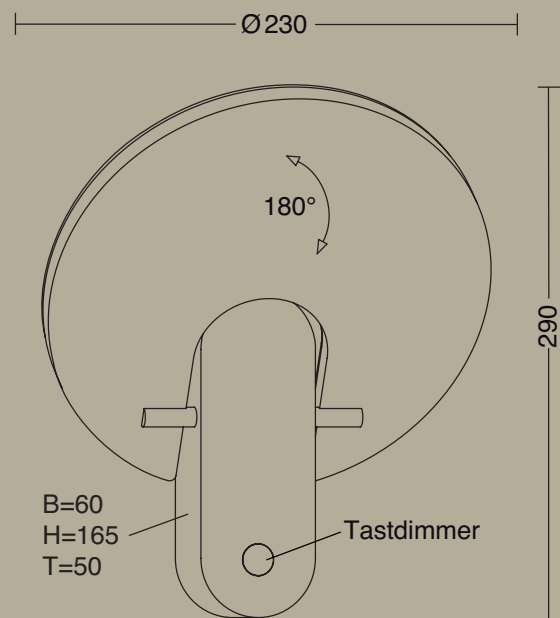

Ausladung min. 50/max. 245

supernova dl

Technische Daten

1x LED
45W - NV-LED
6700 Lumen
2200 - 2900 Kelvin - DIM TO WARM
CRI >90
Dimmbar

Ausführungen

- 2160-1-59 Schwarz / Eloxal Messing
- 2160-1-79 Aluminium matt
- 2160-1-8 Weiß
- 2160-1-879 Weiß / Aluminium matt

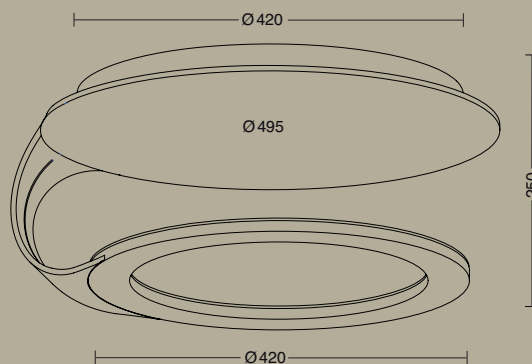

2160-1-59

orbit

Technische Daten

1x LED
39W - NV-LED
5400 Lumen
2700 Kelvin
CRI >90
Dimmbar

Ausführungen

- | | |
|-------------|--------------------------|
| ● 2165-1-55 | Schwarz |
| ● 2165-1-59 | Schwarz / Eloxal Messing |
| ● 2165-1-79 | Aluminium matt |
| ● 2165-1-8 | Weiß |

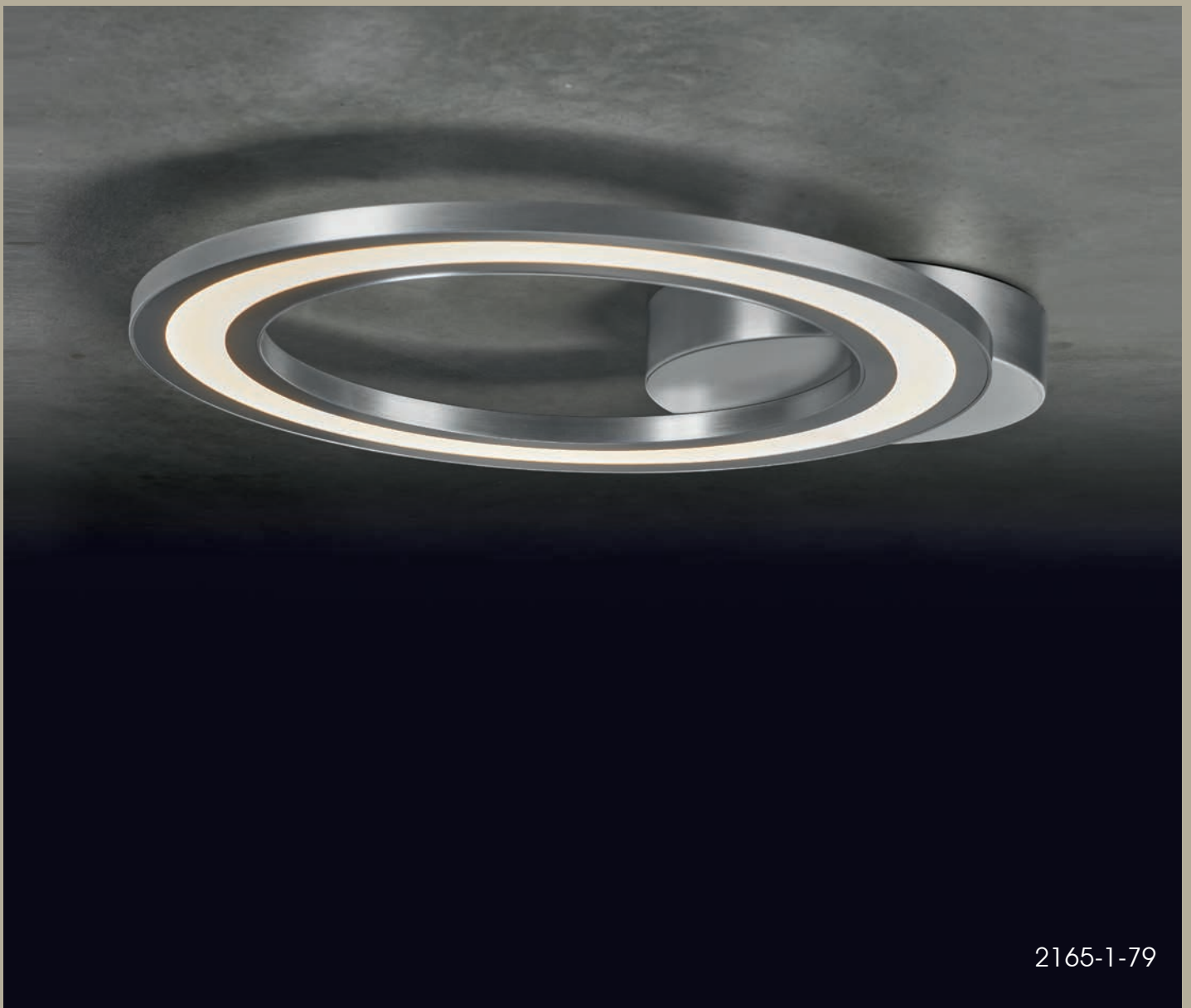
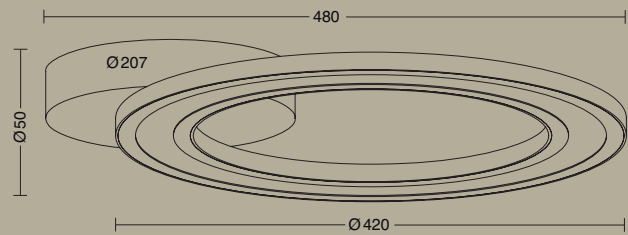

2165-1-79

type

Type S

Milieubild

108-109

Technische Daten

110-111

Type T

Technische Daten

112-113











9930-1-624

type s

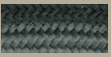

type s

Technische Daten Artikel + Oberfläche + Flexschlauch



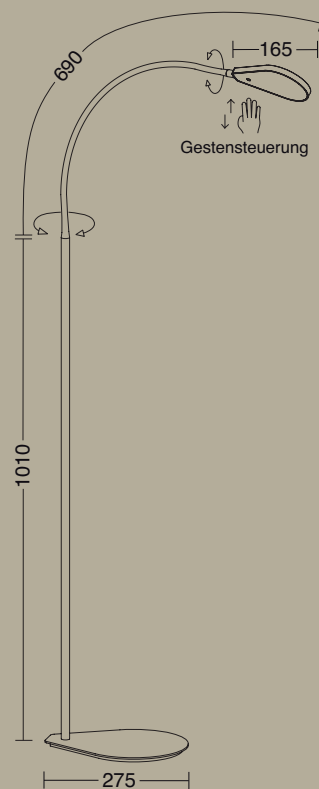





1x LED	9930-1	19		1	
15W - NV-LED		55		2	
1800 Lumen		62		3	
2200 - 2850 Kelvin		79		4	
DIM TO WARM				5	
Dimmbar					

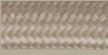

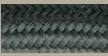

9930-1-555

type t

Technische Daten	Artikel	+	Oberfläche	+	Flexschlauch
1x LED 15W - NV-LED 1800 Lumen 2200 - 2850 Kelvin DIM TO WARM Dimmbar	9931-1		19 		1 
			55 		2 
			62 		3 
			79 		4 
					5 

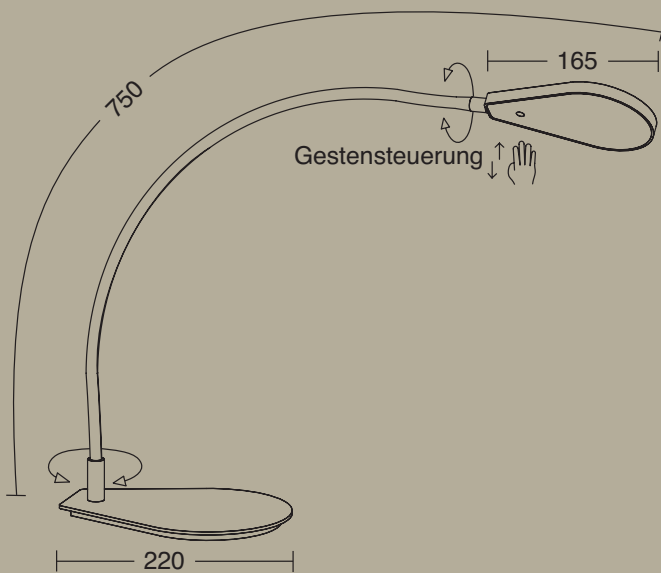



9931-1-625



9931-1-795

avior

Milieubild

116-117

Produktionsbild

118-119

Technische Daten

120-121

avior





2322-2-33



Die Aluminiumprofile werden auf unserem **Stabbearbeitungszentrum**
weiterverarbeitet. Im Bild das **Profil** der **Avior-Pendelleuchte**.

avior

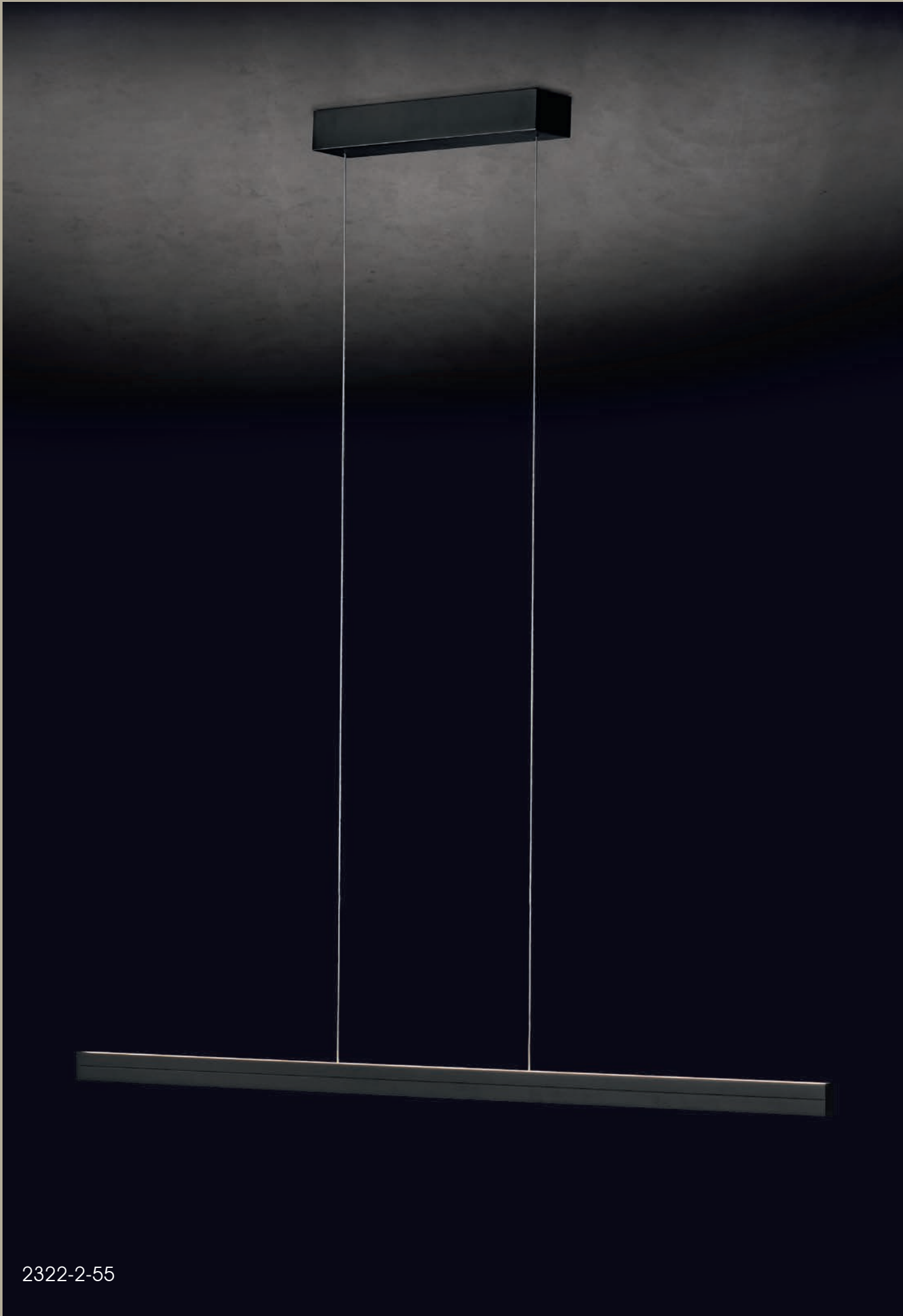





2322-2-55

AVIOR S 825mm

Technische Daten

2x LED
 45W - NV-LED
 4300 Lumen
 2200 - 2850 Kelvin - DIM TO WARM
 CRI >90
 Dimmbar

Ausführungen





	2321-2-19	Eloxal Messing
	2321-2-33	Bronze
	2321-2-55	Schwarz
	2321-2-61	Silbermatt
	2321-2-62	Platin

AVIOR M 1225mm

Technische Daten

2x LED
 67W - NV-LED
 6400 Lumen
 2200 - 2850 Kelvin - DIM TO WARM
 CRI >90
 Dimmbar

Ausführungen





	2322-2-19	Eloxal Messing
	2322-2-33	Bronze
	2322-2-55	Schwarz
	2322-2-61	Silbermatt
	2322-2-62	Platin

AVIOR L 1625mm

Technische Daten

2x LED
 90W - NV-LED
 8500 Lumen
 2200 - 2850 Kelvin - DIM TO WARM
 CRI >90
 Dimmbar

Ausführungen

	2323-2-19	Eloxal Messing
	2323-2-33	Bronze
	2323-2-55	Schwarz
	2323-2-61	Silbermatt
	2323-2-62	Platin

Sonder-Litzenlängen sind auf Anfrage als Sonderanfertigung gegen einen Aufpreis möglich.

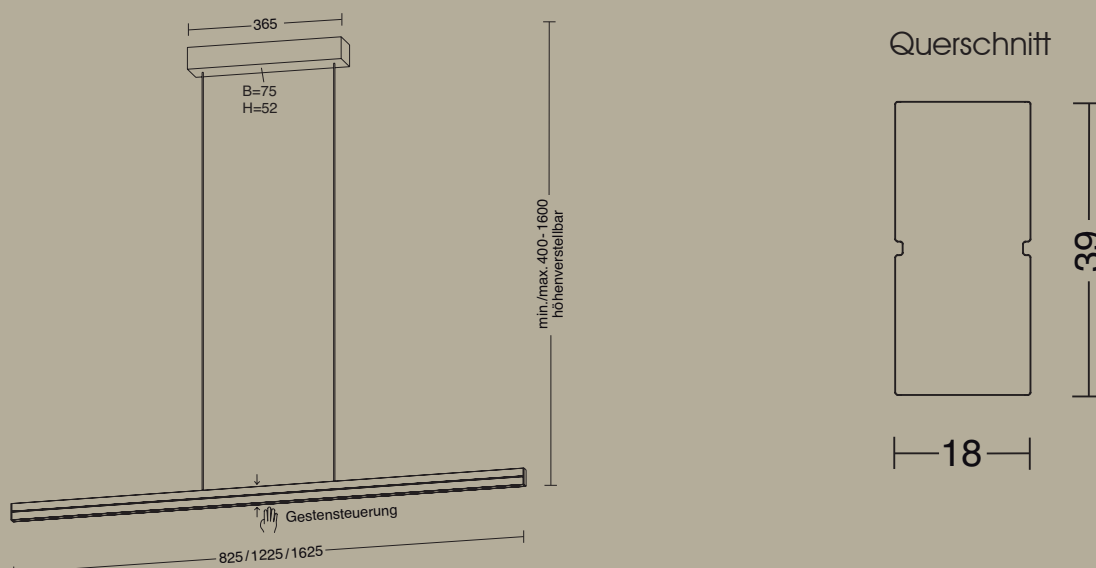

xend

Milieubild

124-125

Technische Daten

126-127



2312-3-55

hammelbeck - Möbel & Innenausbau

xena

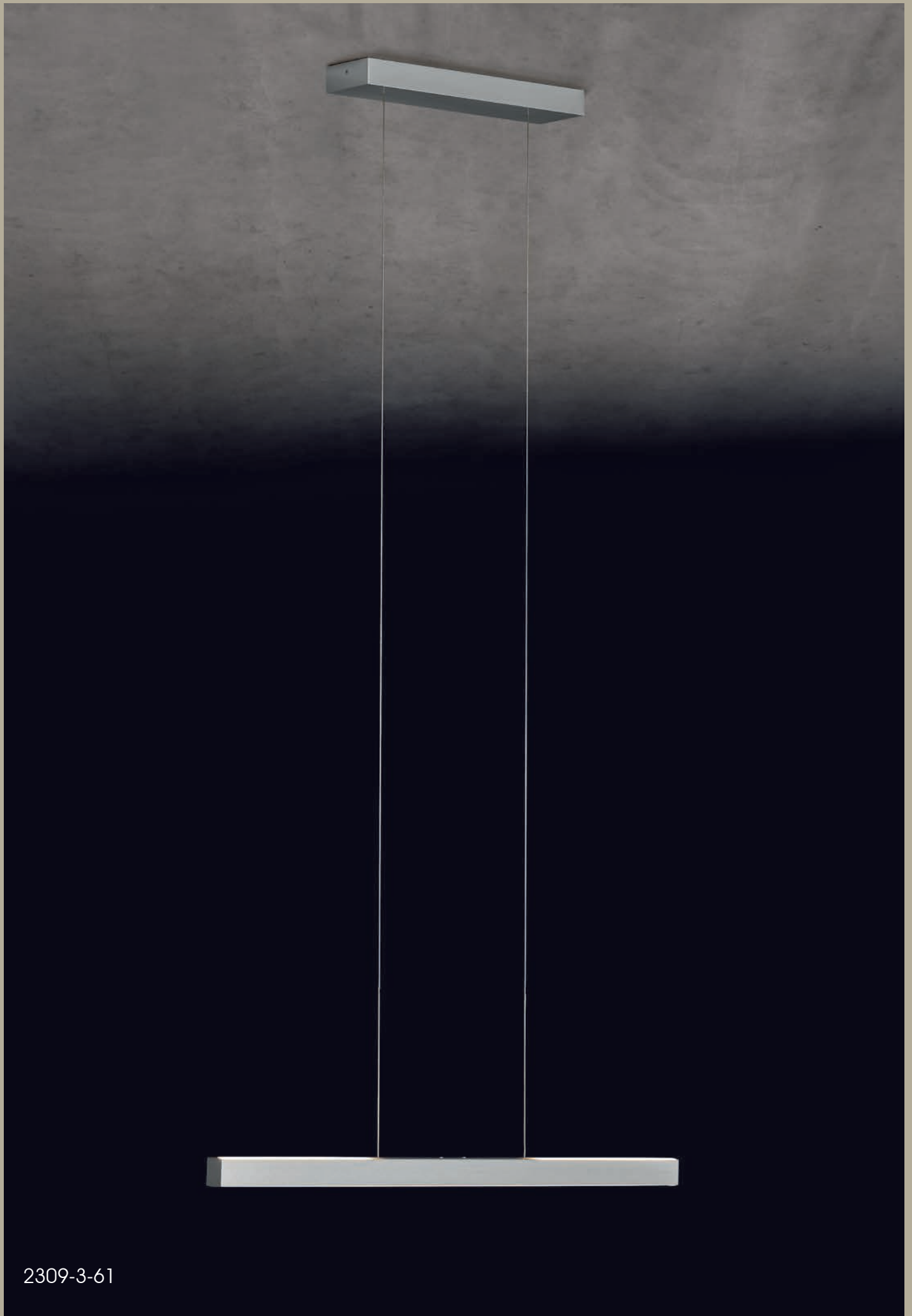

2309-3-61

Technische Daten

3x LED
 42W - NV-LED
 2700 Lumen (Uplight)
 4200 Lumen (Downlight)
 2200 - 2850 Kelvin - DIM TO WARM
 CRI > 90
 Dimmer

Ausführungen XENA XS

Länge 900mm

● 2309-3-19	Eloxal Messing
● 2309-3-33	Bronze
● 2309-3-55	Schwarz
● 2309-3-61	Silbermatt
● 2309-3-62	Platin

Ausführungen XENA S

Länge 1200mm

● 2312-3-19	Eloxal Messing
● 2312-3-33	Bronze
● 2312-3-55	Schwarz
● 2312-3-61	Silbermatt
● 2312-3-62	Platin

Ausführungen XENA L

Länge 1600mm

● 2316-3-19	Eloxal Messing
● 2316-3-33	Bronze
● 2316-3-55	Schwarz
● 2316-3-61	Silbermatt
● 2316-3-62	Platin

Sonder-Litzenlängen sind auf Anfrage als Sonderanfertigung gegen einen Aufpreis möglich.

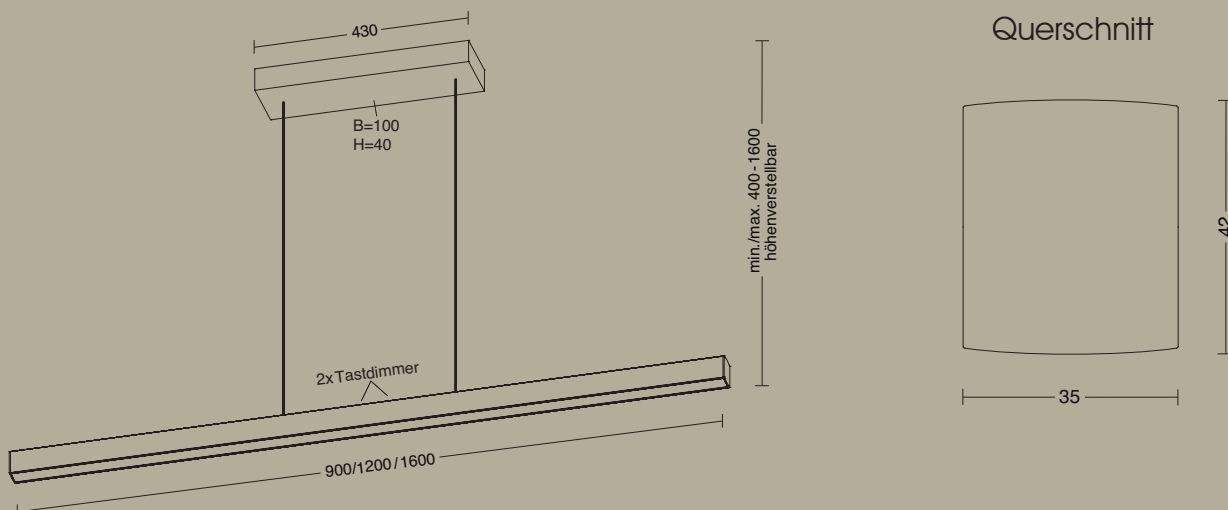

epsilon

Milieubild

130-131

Produktionsbild

132-133

Technische Daten

134-135

epsilon



9236-1-55





Zuschnitt von Aluminiumprofilen. Im Bild das **Profil** der **Epsilon-Pendelleuchte**.

epsilon

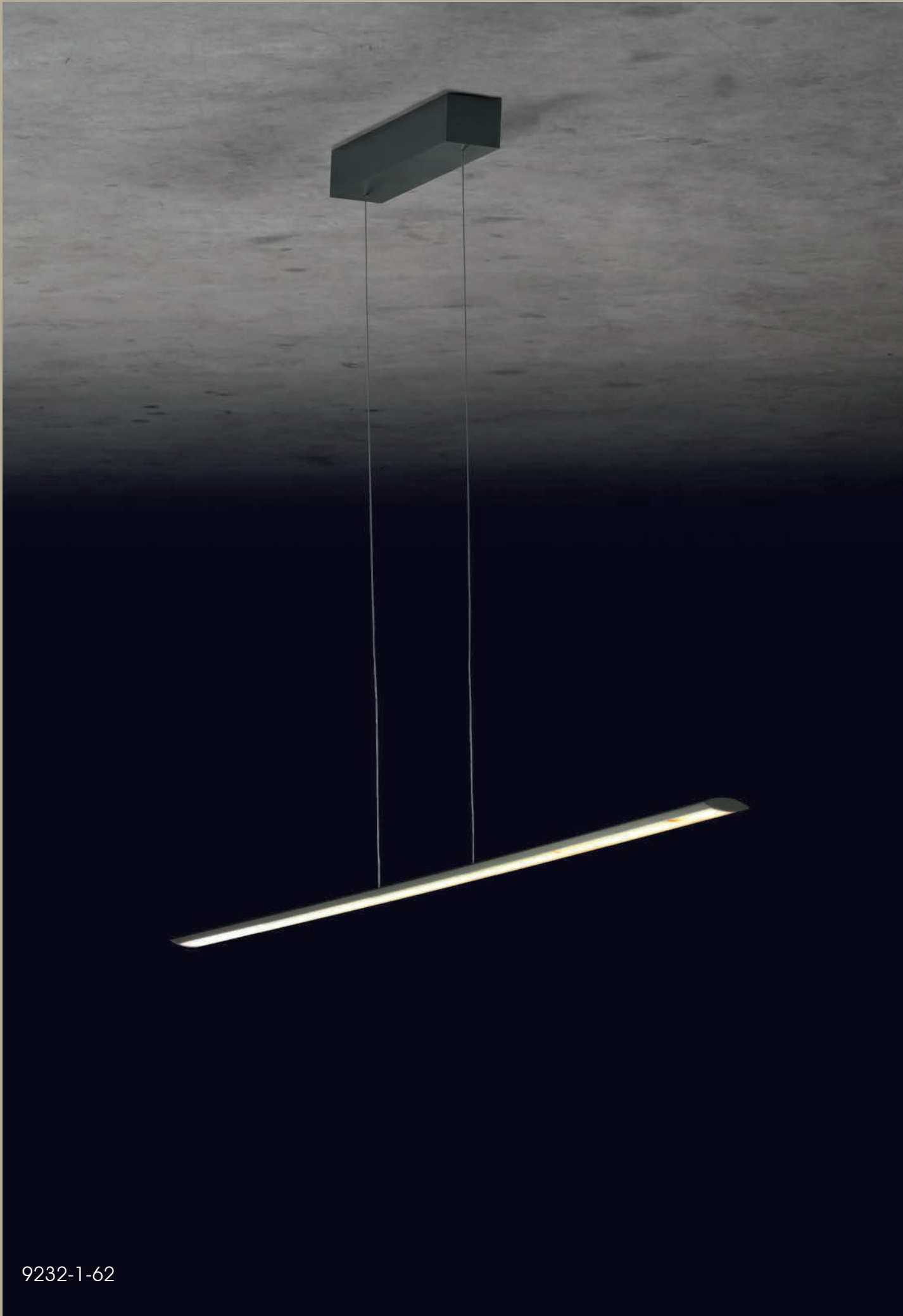

9232-1-62

epsilon

EPSILON 830mm

Technische Daten

1x LED
29W - NV-LED
3000 Lumen
2200 - 2700 Kelvin - DIM TO WARM
CRI >90
Dimmbar

Ausführungen

● 9231-1-19	Eloxal Messing
● 9231-1-55	Schwarz
● 9231-1-61	Silbermatt
● 9231-1-62	Platin

EPSILON 1230mm

Technische Daten

1x LED
43W - NV-LED
4400 Lumen
2200 - 2700 Kelvin - DIM TO WARM
CRI >90
Dimmbar

Ausführungen

● 9232-1-19	Eloxal Messing
● 9232-1-55	Schwarz
● 9232-1-61	Silbermatt
● 9232-1-62	Platin

EPSILON 1630mm

Technische Daten

1x LED
58W - NV-LED
5900 Lumen
2200 - 2700 Kelvin - DIM TO WARM
CRI >90
Dimmbar

Ausführungen

● 9236-1-19	Eloxal Messing
● 9236-1-55	Schwarz
● 9236-1-61	Silbermatt
● 9236-1-62	Platin

Sonder-Litzenlängen sind auf Anfrage als Sonderanfertigung gegen einen Aufpreis möglich.

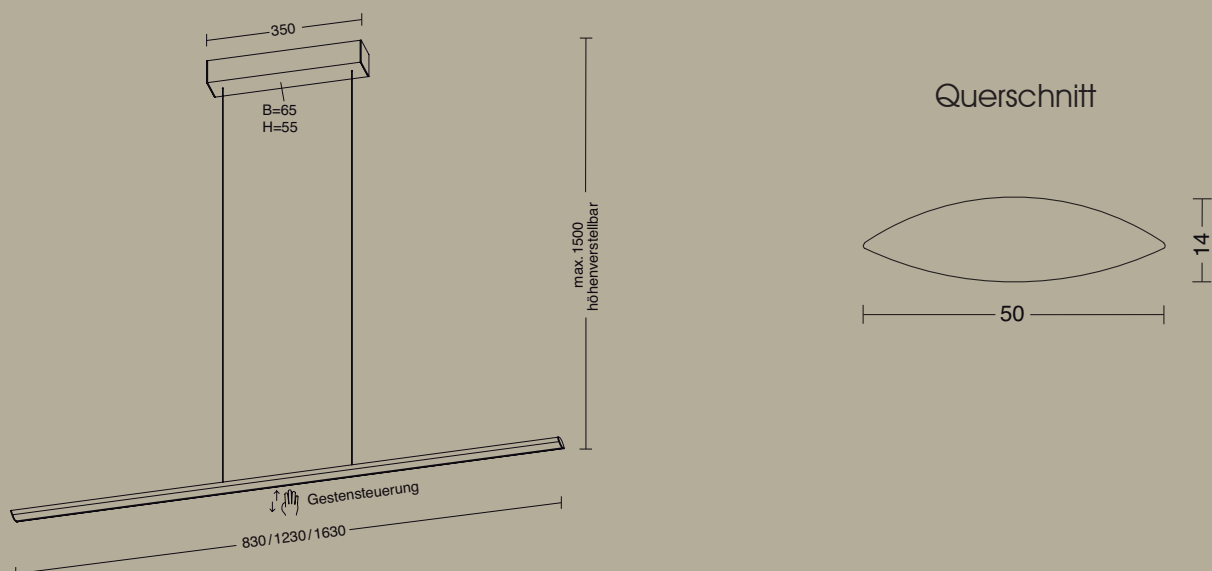

aura

Aura S

Milieubild	138-139
Technische Daten	140-141

Aura A / E / P1

Technische Daten	142-143
------------------	---------

Aura P2

Technische Daten	144-145
------------------	---------

Aura P3 / R3

Technische Daten	146-147
------------------	---------

aura



2020-1-55 + M20-19; 2025-3-55 + 3x GL20-51



aura s

Technische Daten

1x LED
16,6W - NV-LED
1660 Lumen
1800 - 2900 Kelvin - DIM TO WARM
CRI >95
Dimmer

Ausführungen

- 2020-1-19 Eloxal Messing
- 2020-1-55 Schwarz
- 2020-1-62 Platin
- 2020-1-79 Aluminium matt

Mundgeblasene Gläser

- GL20-23 Opal matt
- GL20-24 Opal matt plissiert
- GL20-43 Amber
- GL20-51 Cognac
- GL20-63 Rauchgrau

Reflektoren

- M20-19 Eloxal Messing
- M20-55 Schwarz
- M20-62 Platin
- M20-79 Aluminium matt

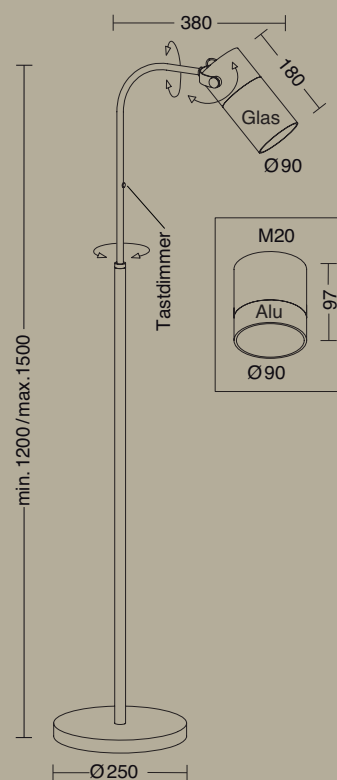

2020-1-55 + GL20-51



2020-1-62 + M20-79

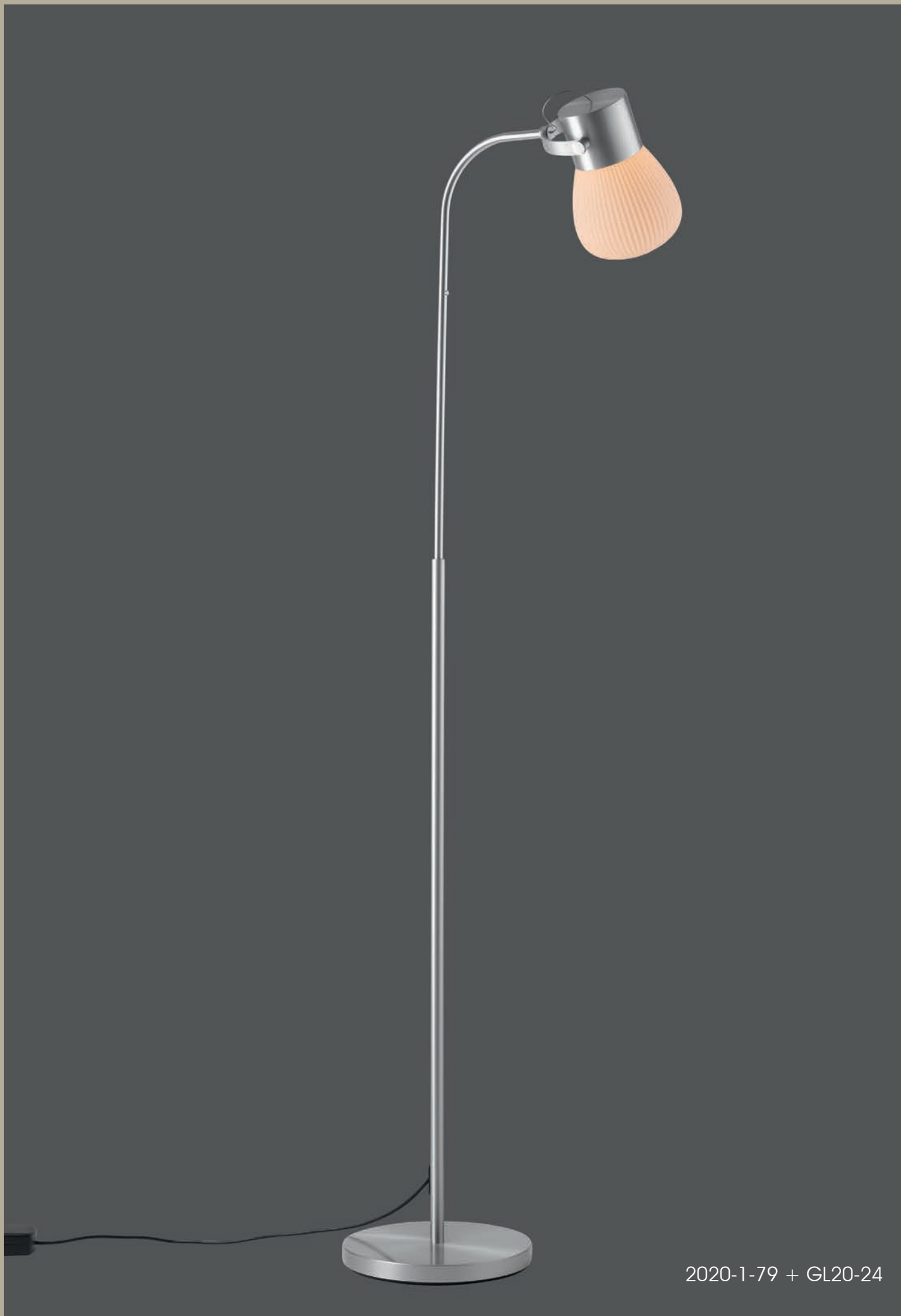

2020-1-79 + GL20-24

aura p1 / a / e

AURA P1

Technische Daten

1x LED
 16,6W - NV-LED
 1660 Lumen
 1800 - 2900 Kelvin
 DIM TO WARM
 CRI >95
 Dimmbar

Ausführungen

-  2028-1-19
-  2028-1-55
-  2028-1-62
-  2028-1-79

Eloxal Messing
 Schwarz
 Platin
 Aluminium matt

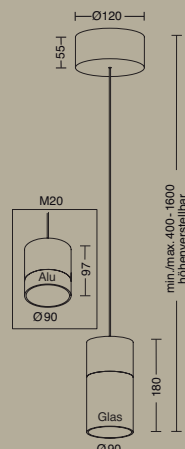

AURA A

Technische Daten

1x LED
 16,6W - NV-LED
 1660 Lumen
 1800 - 2900 Kelvin
 DIM TO WARM
 CRI >95
 Dimmbar

Ausführungen

-  2027-1-19
-  2027-1-55
-  2027-1-62
-  2027-1-79

Eloxal Messing
 Schwarz
 Platin
 Aluminium matt

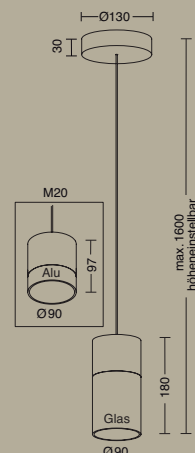

AURA E

Technische Daten

1x LED
 16,6W - NV-LED
 1660 Lumen
 1800 - 2900 Kelvin
 DIM TO WARM
 CRI >95
 Dimmbar



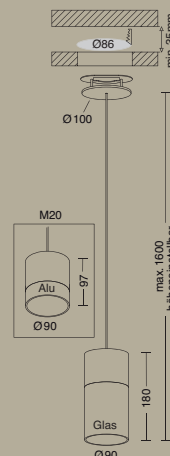

Ausführungen

-  2026-1-19
-  2026-1-55
-  2026-1-62
-  2026-1-79





Eloxal Messing
 Schwarz
 Platin
 Aluminium matt



Mundgeblasene Gläser

-  GL20-23 Opal matt
-  GL20-24 Opal matt plissiert
-  GL20-43 Amber
-  GL20-51 Cognac
-  GL20-63 Rauchgrau

Reflektoren

-  M20-19 Eloxal Messing
-  M20-55 Schwarz
-  M20-62 Platin
-  M20-79 Aluminium matt

Sonder-Litzenlängen sind auf Anfrage als Sonderanfertigung gegen einen Aufpreis möglich.



2028-1-55 + M20-19

aura p2

Technische Daten

2x LED
2x 16,6W - NV-LED
3320 Lumen
1800 - 2900 Kelvin - DIM TO WARM
CRI >95
Dimmbar

Ausführungen

- 2022-2-19 Eloxal Messing
- 2022-2-55 Schwarz
- 2022-2-62 Platin
- 2022-2-79 Aluminium matt

Mundgeblasene Gläser

- GL20-23 Opal matt
- GL20-24 Opal matt plissiert
- GL20-43 Amber
- GL20-51 Cognac
- GL20-63 Rauchgrau

Reflektoren

- M20-19 Eloxal Messing
- M20-55 Schwarz
- M20-62 Platin
- M20-79 Aluminium matt

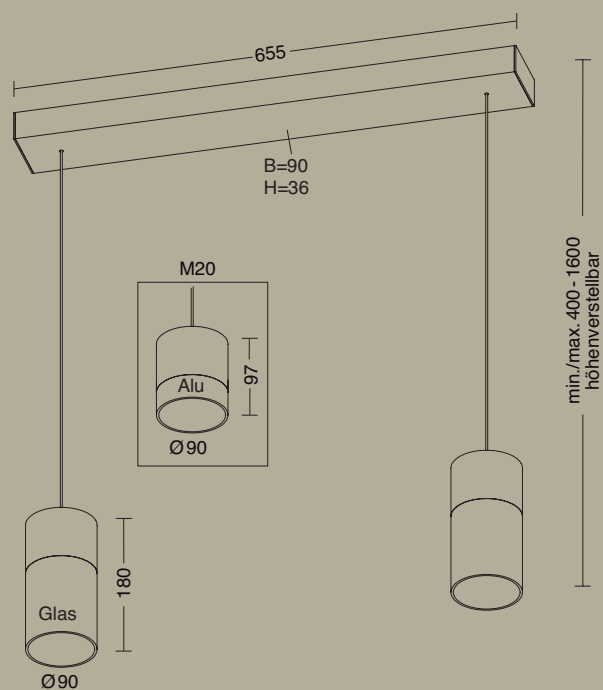

Sonder-Litzenlängen sind auf Anfrage als Sonderanfertigung gegen einen Aufpreis möglich.



2022-2-19 + 2x GL20-43





aura p3 / aura r3

AURA P3





Technische Daten

3x LED
 3x 16,6W - NV-LED
 4980 Lumen
 1800 - 2900 Kelvin - DIM TO WARM
 CRI >95
 Dimmbar





Ausführungen

-  2023-3-19 Eloxal Messing
-  2023-3-55 Schwarz
-  2023-3-62 Platin
-  2023-3-79 Aluminium matt

Mundgeblasene Gläser

-  GL20-23 Opal matt
-  GL20-24 Opal matt plissiert
-  GL20-43 Amber
-  GL20-51 Cognac
-  GL20-63 Rauchgrau

Reflektoren





-  M20-19 Eloxal Messing
-  M20-55 Schwarz
-  M20-62 Platin
-  M20-79 Aluminium matt

AURA R3





Technische Daten

3x LED
 3x 16,6W - NV-LED
 4980 Lumen
 1800 - 2900 Kelvin - DIM TO WARM
 CRI >95
 Dimmbar





Ausführungen

-  2025-3-19 Eloxal Messing
-  2025-3-55 Schwarz
-  2025-3-62 Platin
-  2025-3-79 Aluminium matt

Mundgeblasene Gläser

-  GL20-23 Opal matt
-  GL20-24 Opal matt plissiert
-  GL20-43 Amber
-  GL20-51 Cognac
-  GL20-63 Rauchgrau

Reflektoren

-  M20-19 Eloxal Messing
-  M20-55 Schwarz
-  M20-62 Platin
-  M20-79 Aluminium matt

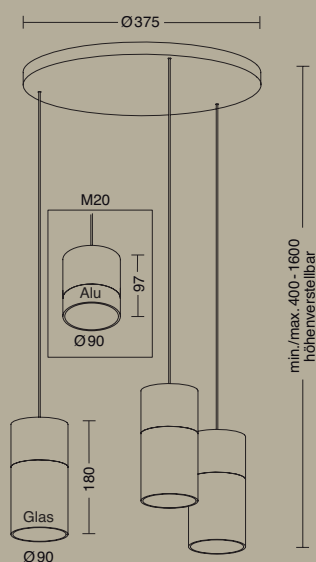
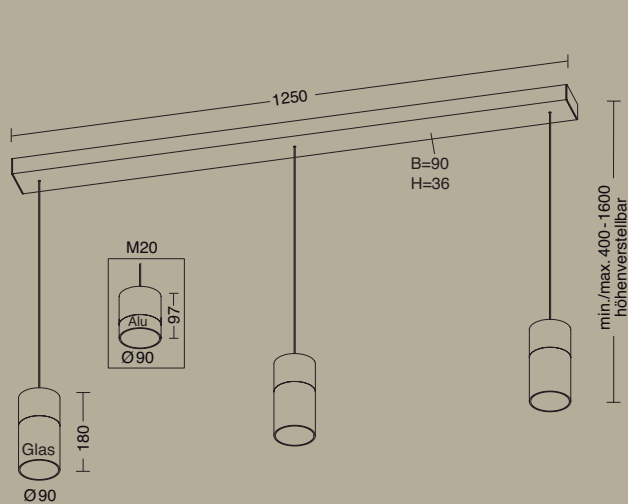

Sonder-Litzenlängen sind auf Anfrage als Sonderanfertigung gegen einen Aufpreis möglich.



2023-3-79 + 3x M20-62

nova

Nova Oog

Milieubild	150-151
Produktionsbild	152-153
Technische Daten	154-155

Nova

Milieubild	156-157
Produktionsbild	158-159
Technische Daten	160-161

Nova Plano

Produktionsbild	162-163
Technische Daten	164-165



9907-2-59

nova oog



nova oog



Die langjährige Erfahrung unserer Mitarbeiter, Fingerspitzengefühl und regelmäßiges Überprüfen der **Oberfläche** führen zum eleganten und unverkennbaren **Schliffbild** auf unseren Leuchten.



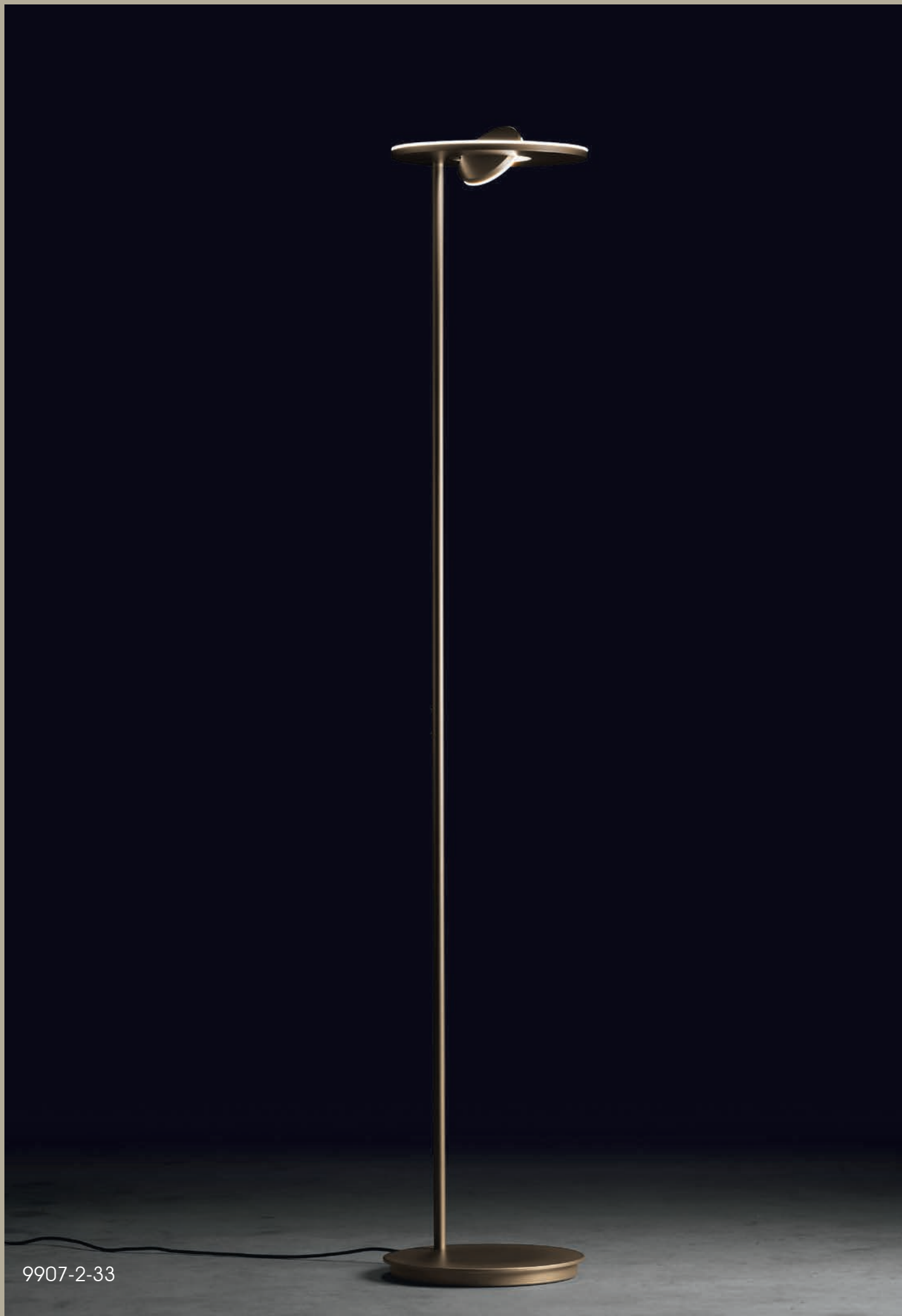

9907-2-33

nova oog

Technische Daten Innenring

1x LED
19W - NV-LED
2200 Lumen
2700 Kelvin
CRI >90
Dimmer

Technische Daten Außenring

1x LED
48W - NV-LED
6500 Lumen
2700 Kelvin
CRI >90
Dimmer

Ausführungen

- | | |
|-------------|--------------------------|
| ● 9907-2-19 | Eloxal Messing |
| ● 9907-2-33 | Bronze |
| ● 9907-2-55 | Schwarz |
| ● 9907-2-59 | Schwarz / Eloxal Messing |
| ● 9907-2-62 | Platin |
| ● 9907-2-79 | Aluminium matt |
| ● 9907-2-8 | Weiß |

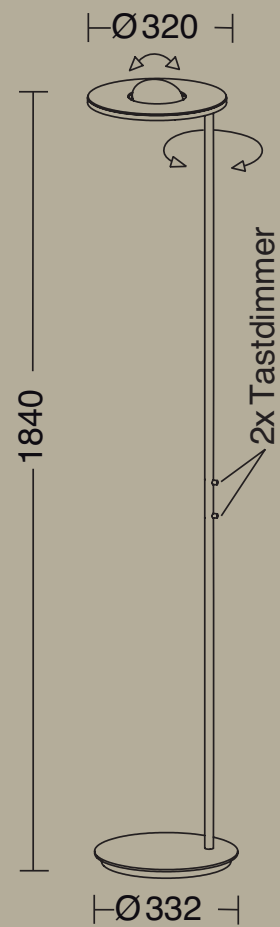

9907-2-55

nova



9906-2-55



nova



Der **Deckenfluter Nova** - **9906-2-19** - ist fertig montiert und wird ein letztes Mal kontrolliert bevor er verpackt und verschickt wird.



nova

Technische Daten Innenring

1x LED
14W - NV-LED
2200 Lumen
2700 Kelvin
CRI >90
Dimmer

Technische Daten Außenring

1x LED
47W - NV-LED
6800 Lumen
2700 Kelvin
CRI >90
Dimmer

Ausführungen

● 9906-2-19	Eloxal Messing
● 9906-2-33	Bronze
● 9906-2-55	Schwarz
● 9906-2-59	Schwarz / Eloxal Messing
● 9906-2-62	Platin
● 9906-2-79	Aluminium matt
● 9906-2-8	Weiß

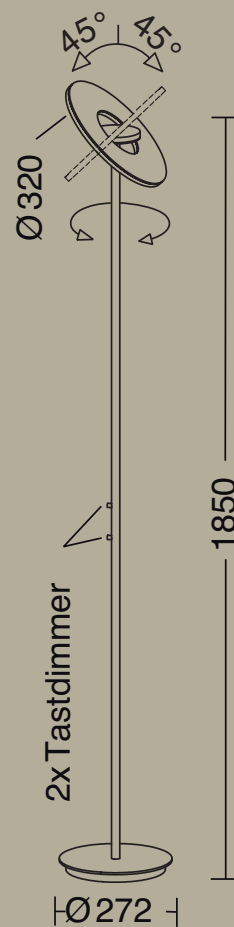

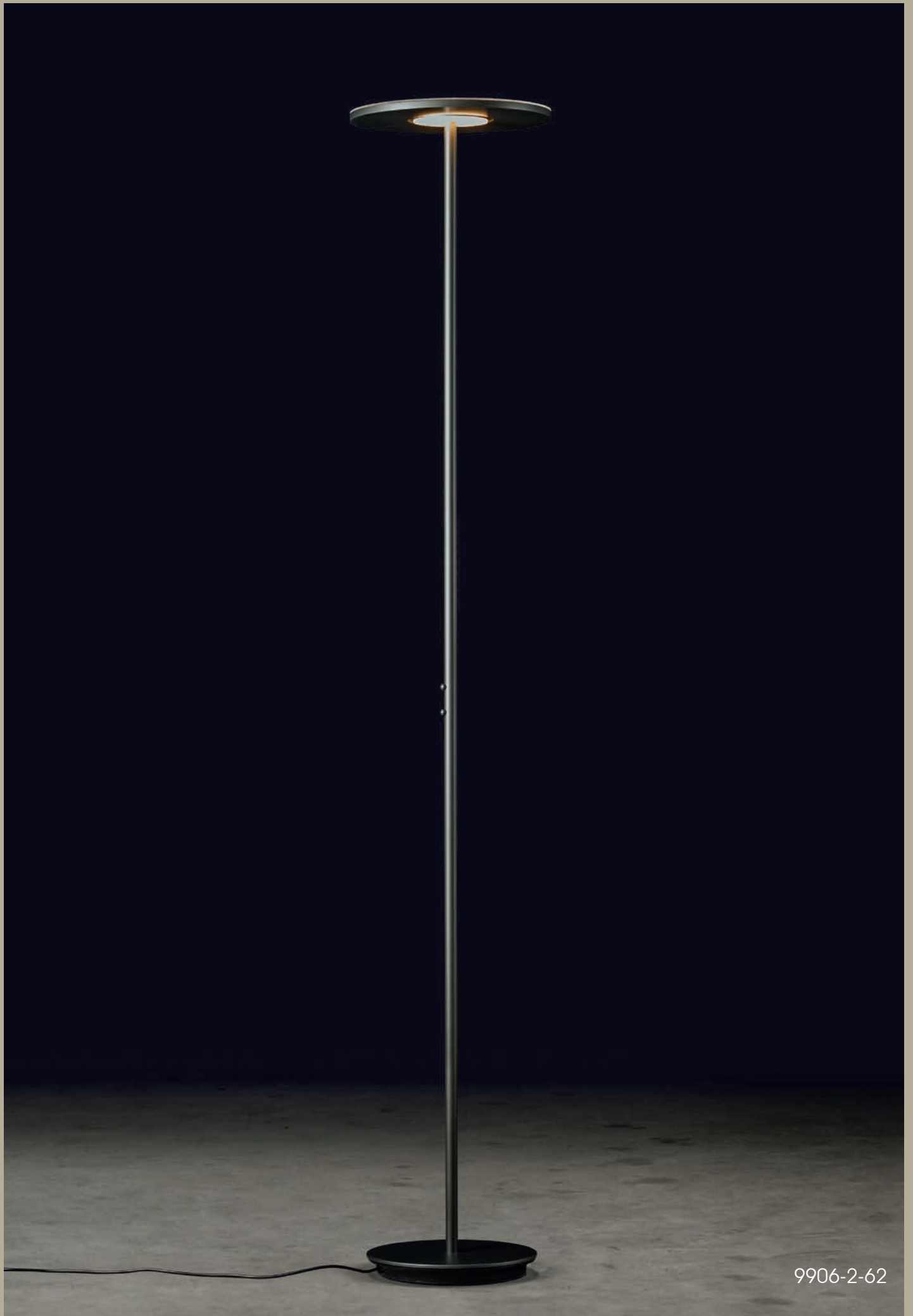

9906-2-62



nova plano

Tiefziehen: Aus einem einfachen Metallblech entsteht mithilfe von mehreren Verfahrensschritten ein eleganter **Leuchtensockel**. Die zum Tiefziehen benötigten Werkzeuge stellen wir im hauseigenen Werkzeugbau selber her.





9909-2-19

nova plano

Technische Daten Ring

1x LED
47W - NV-LED
6500 Lumen
2700 Kelvin
CRI >90
Dimmer

Technische Daten Seitenarm

1x LED
19W - NV-LED
2200 Lumen
2700 Kelvin
CRI >90
Dimmer

Ausführungen

- 9909-2-19 Eloxal Messing
- 9909-2-33 Bronze
- 9909-2-55 Schwarz
- 9909-2-62 Platin
- 9909-2-79 Aluminium matt

112076 optionale Acrylscheibe

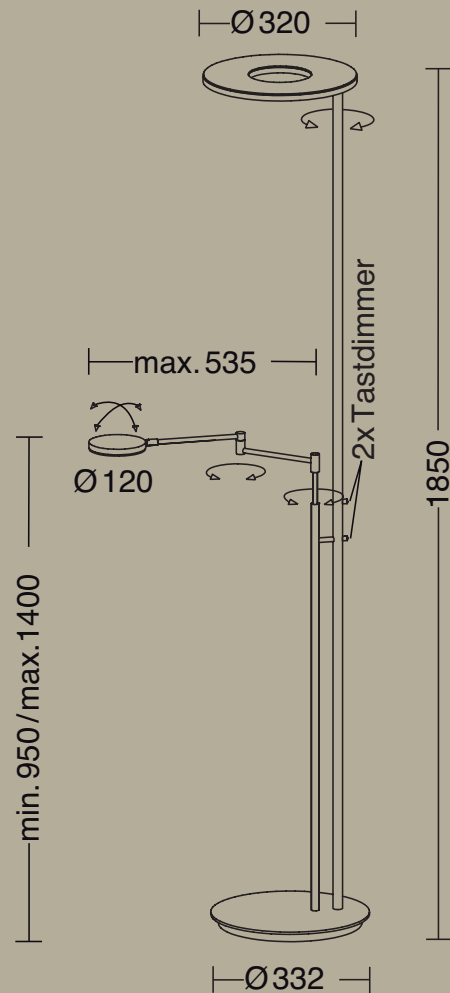

plano

Plano B

Milieubild	168-169
Produktionsbild	170-171
Technische Daten	172-173

Plano S

Technische Daten	174-175
------------------	---------

Plano Twin

Technische Daten	176-177
------------------	---------

Plano T

Technische Daten	178-179
------------------	---------

Plano

Technische Daten	180-181
------------------	---------

Plano WB

Technische Daten	182-183
------------------	---------

Plano W

Technische Daten	184
------------------	-----

Plano WD

Technische Daten	185
------------------	-----

plano b



9656-1-19





Lackiererei: Die Farben „Bronze“, „Eloxal Messing“ und „Platin“ gibt es so nirgendwo zu kaufen. Sie werden in unserer hauseigenen Lackiererei angemischt und mit viel Erfahrung und Know-how aufgetragen.



Die **Endmontage** ist der letzte Schritt im Herstellungsprozess. Hier werden alle metallischen und auch elektrotechnischen Bauteile zusammengefügt und zu einer funktionsfähigen Leuchte montiert. Das Gewinde, das das Rohr und den Sockel der **Plano-Leseleuchte** verbindet, muss immer im selben Abstand verbaut werden. So bleibt die Leuchte standfest.



9656-1-33 + optionale Acrylscheibe 112076

plano b

Technische Daten

1x LED
19W - NV-LED
2200 Lumen
2700 Kelvin
CRI >90
Dimmer

Ausführungen

- 9656-1-19 Eloxal Messing
- 9656-1-33 Bronze
- 9656-1-55 Schwarz
- 9656-1-59 Schwarz / Eloxal Messing
- 9656-1-62 Platin
- 9656-1-79 Aluminium matt
- 9656-1-8 Weiß

112076 optionale Acrylscheibe

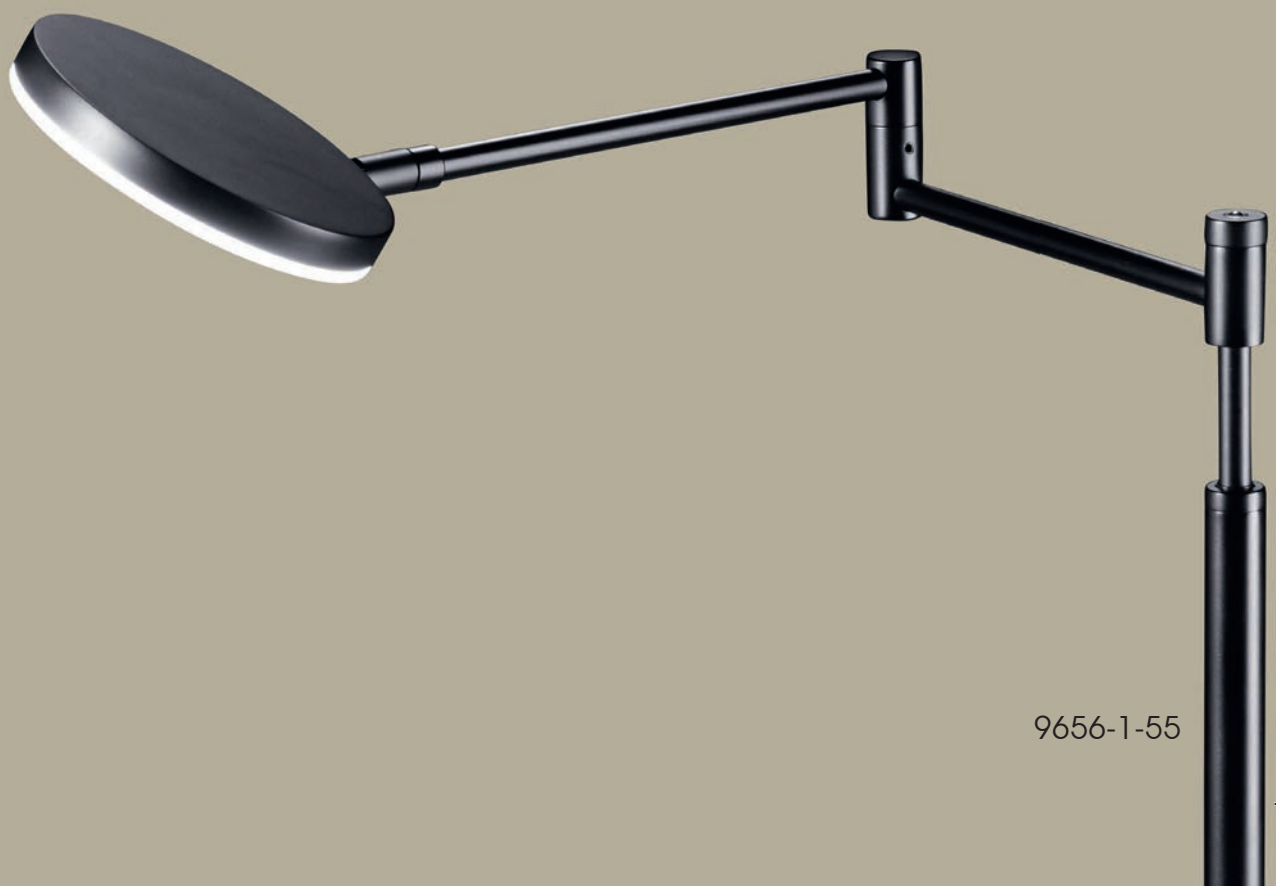
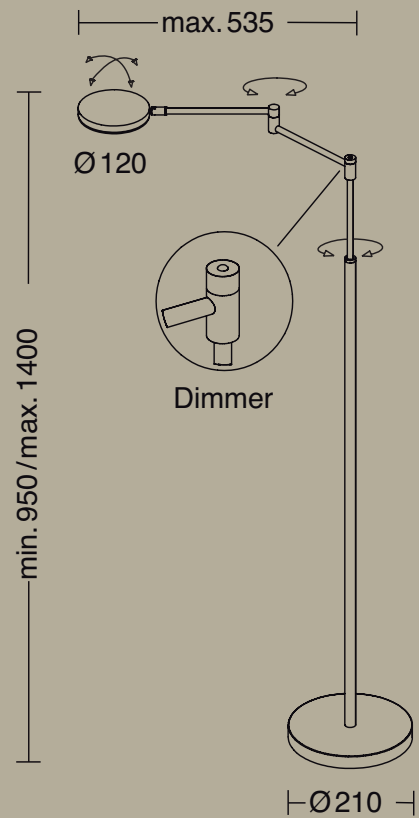



9659-1-19

plano s

Technische Daten

1x LED
19W - NV-LED
2200 Lumen
2700 Kelvin
CRI >90
Dimmer

Ausführungen

- | | |
|-------------|----------------|
| ● 9659-1-19 | Eloxal Messing |
| ● 9659-1-55 | Schwarz |
| ● 9659-1-62 | Platin |
| ● 9659-1-79 | Aluminium matt |
- 112076 optionale Acrylscheibe

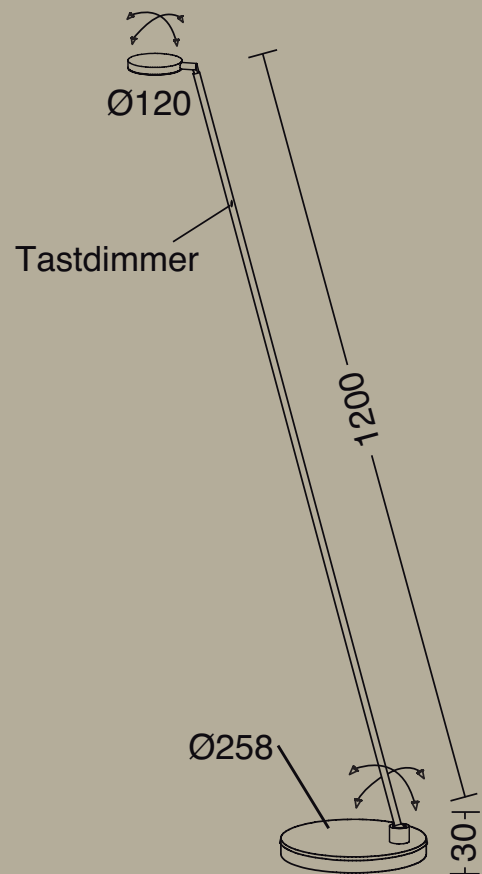

Ausladung · Extension max. 850

plano twin

Technische Daten

2x LED
2x 19W - NV-LED
4400 Lumen
2700 Kelvin
CRI >90
Dimmer

Ausführungen

- 9652-2-19 Eloxal Messing
- 9652-2-33 Bronze
- 9652-2-55 Schwarz
- 9652-2-62 Platin
- 9652-2-79 Aluminium matt

112076 optionale Acrylscheibe

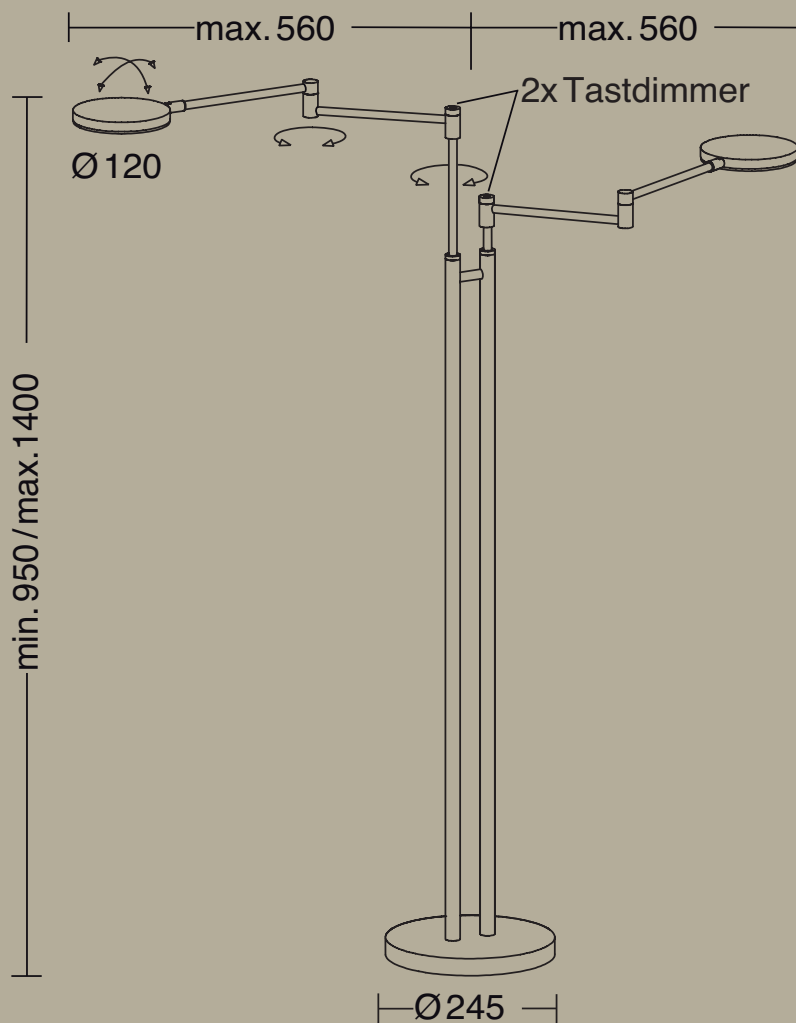



9652-2-19

plano t

Technische Daten

1x LED
19W - NV-LED
2200 Lumen
2700 Kelvin
CRI >90
Dimmer

Ausführungen

● 9657-1-19	Eloxal Messing
● 9657-1-33	Bronze
● 9657-1-55	Schwarz
● 9657-1-62	Platin
● 9657-1-79	Aluminium matt
● 9657-1-8	Weiß
112076	optionale Acrylscheibe

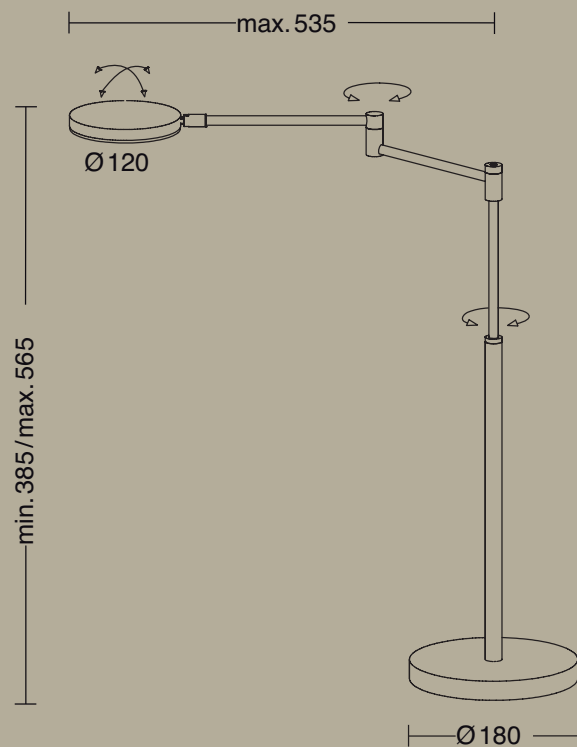



9657-1-79

plano

Technische Daten

4x LED
4x 10W - NV-LED
7000 Lumen
2700 Kelvin
CRI >90
Dimmer

Ausführungen

- 9901-4-55 Schwarz
- 9901-4-62 Platin
- 9901-4-79 Aluminium matt

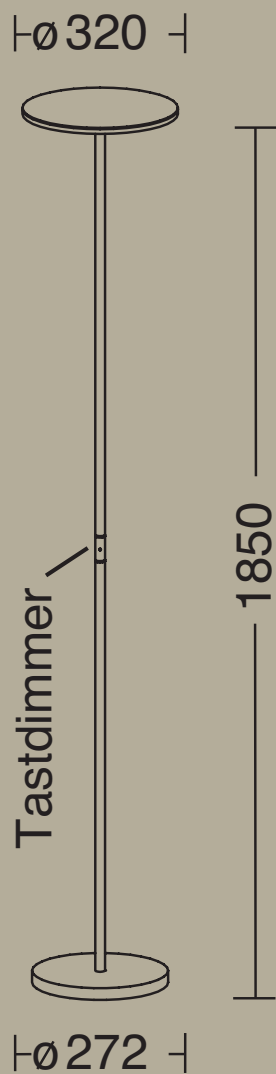

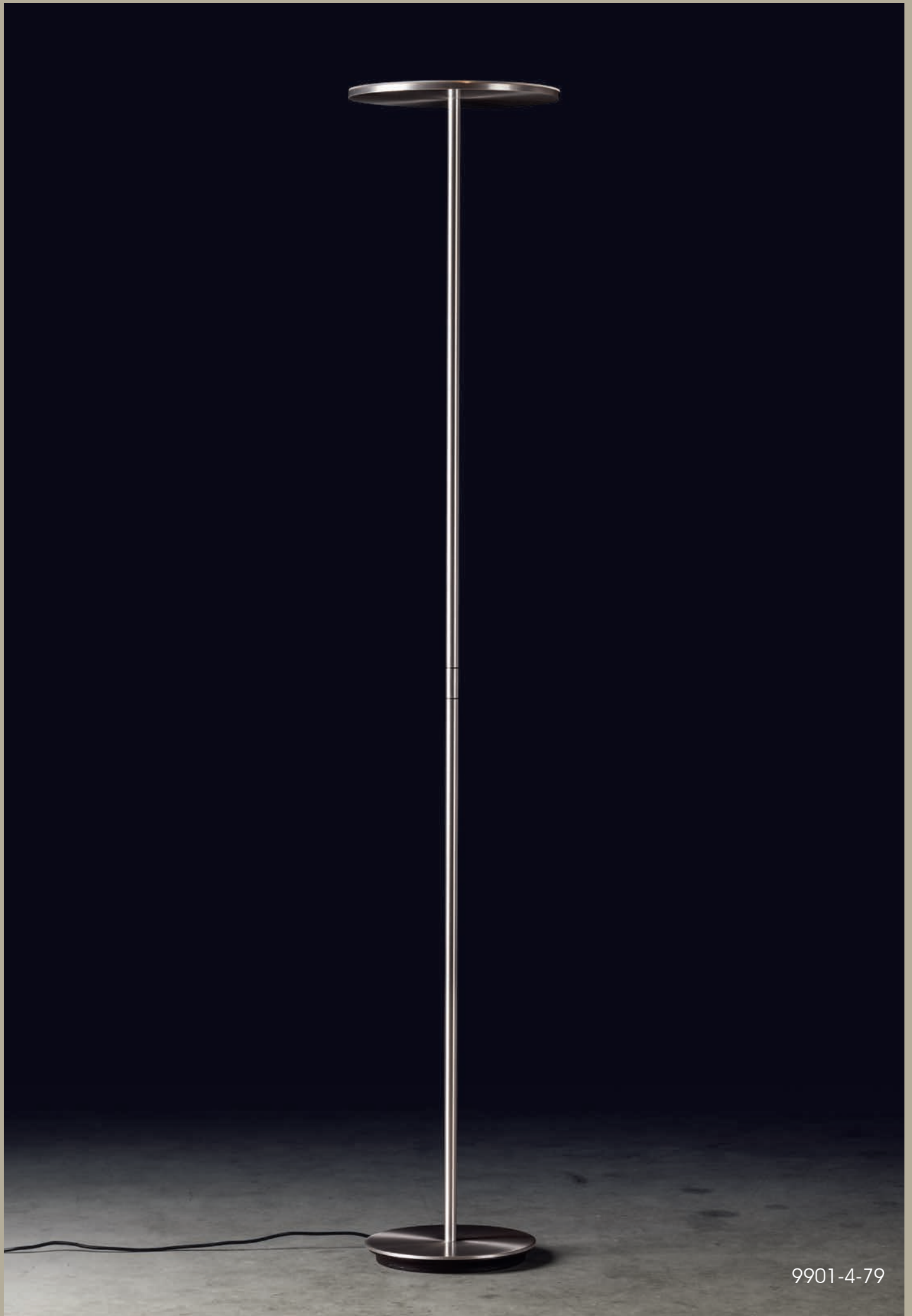

9901-4-79

plano wb

Technische Daten

1x LED
14W - NV-LED
2000 Lumen
2700 Kelvin
CRI >90
Dimmer

Ausführungen

- | | |
|-------------|----------------|
| ● 9658-1-19 | Eloxal Messing |
| ● 9658-1-33 | Bronze |
| ● 9658-1-55 | Schwarz |
| ● 9658-1-62 | Platin |
| ● 9658-1-79 | Aluminium matt |

112076 optionale Acrylscheibe

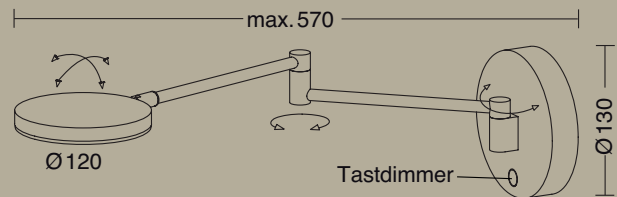



9658-1-19



9658-1-79

plano w

Technische Daten Plano W

1x LED
14W - NV-LED
2000 Lumen
2700 Kelvin
CRI >90
Dimmbar

Ausführungen

- | | |
|-------------|----------------|
| ● 9915-1-19 | Eloxal Messing |
| ● 9915-1-55 | Schwarz |
| ● 9915-1-62 | Platin |
| ● 9915-1-79 | Aluminium matt |
| ● 9915-1-8 | Weiß |

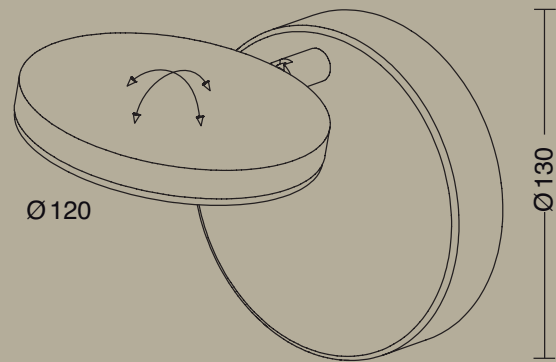

Ausladung·Extension max. 155



9915-1-62

plano wd

Technische Daten Plano WD

1x LED
14W - NV-LED
2000 Lumen
2700 Kelvin
CRI >90
Dimmer

Ausführungen

- | | |
|-------------|----------------|
| ● 9914-1-19 | Eloxal Messing |
| ● 9914-1-55 | Schwarz |
| ● 9914-1-62 | Platin |
| ● 9914-1-79 | Aluminium matt |
| ● 9914-1-8 | Weiß |

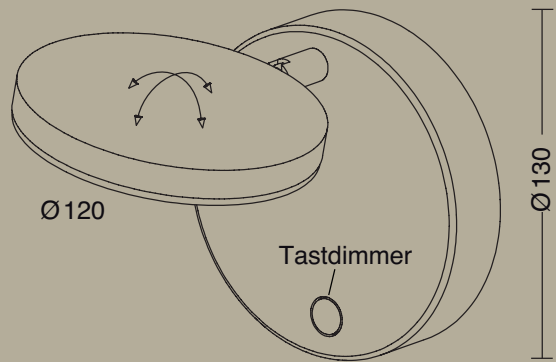

Ausladung-Extension max. 155



9914-1-79

flex

Flex S

Milieubild	188-189
Produktionsbild	190-191
Technische Daten	192-193

Flex Twin

Milieubild	194-195
Technische Daten	196-197

Flex T / K

Technische Daten	198-199
------------------	---------

Flex W

Technische Daten	200-201
------------------	---------

Flex D3 / D5

Technische Daten	202-203
------------------	---------

Nova Flex

Technische Daten	204-205
------------------	---------

flex

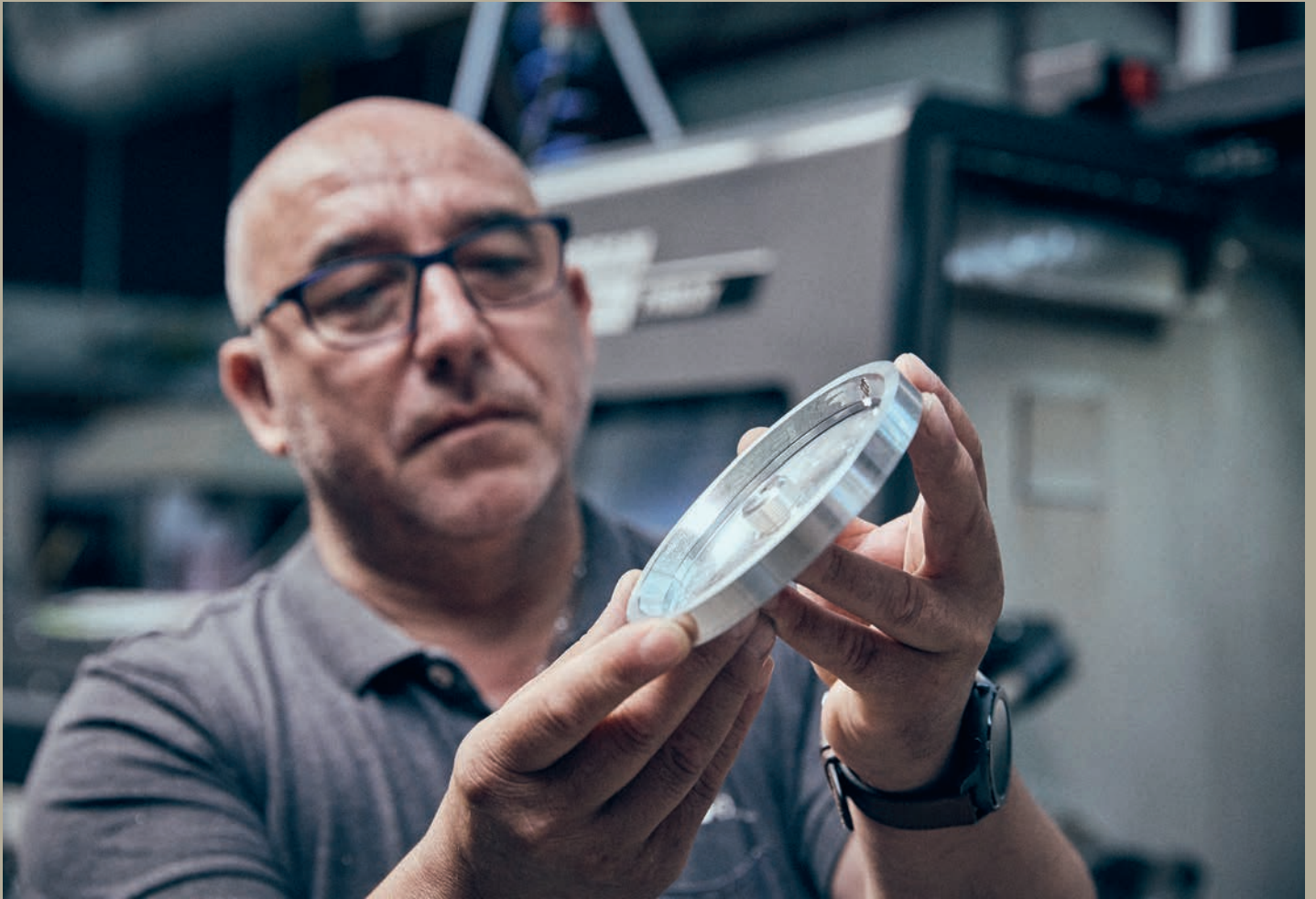

Kein Leuchtenkopf wird so häufig gebraucht wie dieser hier. Ob für die **Plano-/ Flex-/ oder Nova-Serie**, dieser Reflektor sorgt immer für eine hochwertige Ausleuchtung. Er wird von uns auf **CNC-Maschinen** hergestellt.



Nur durch **sorgfältige Verpackung** kommt die Leuchte heile an ihr Ziel.

flex s



9920-1-555



flex s

Technische Daten Artikel + Oberfläche + Flexschlauch

1x LED
 19W - NV-LED
 2200 Lumen
 2700 Kelvin
 Dimmer

Artikel	Oberfläche	Flexschlauch
9920-1	19 	1 
	55 	2 
	62 	3 
	79 	4 
		5 

112076 optionale Acrylscheibe

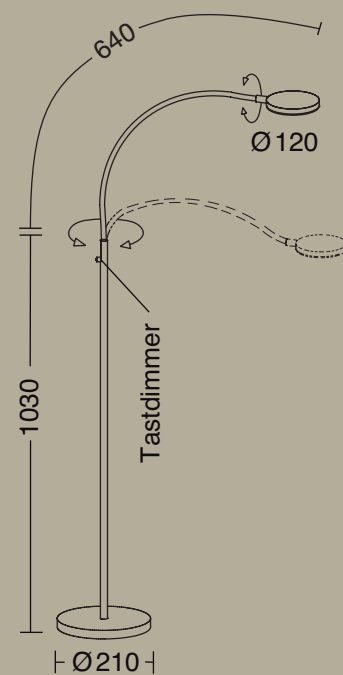

9920-1-553

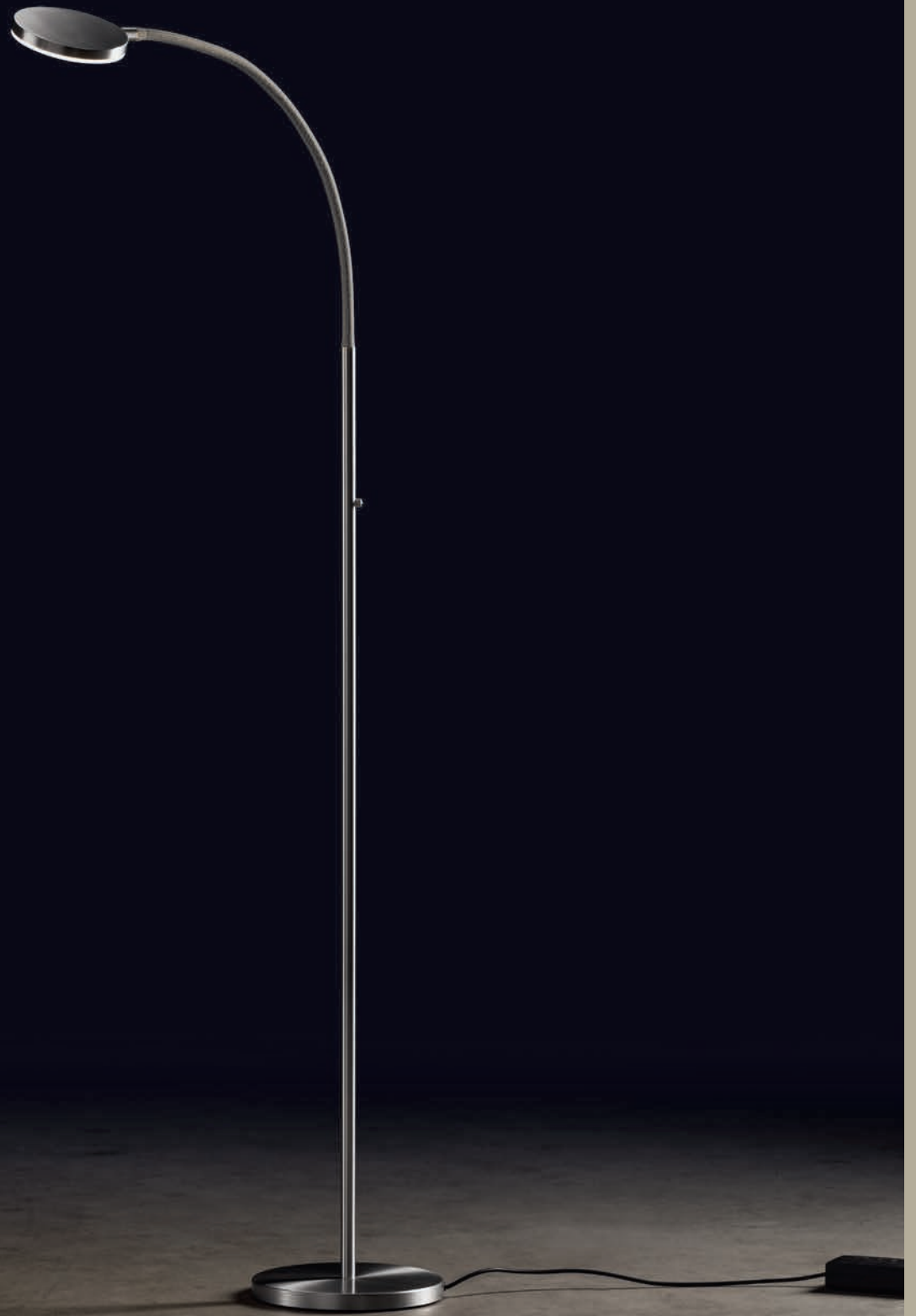

9920-1-794

flex twin



9924-2-794





9924-2-794

flex twin

Technische Daten	Artikel	+	Oberfläche	+	Flexschlauch
2x LED	9924-2	+	19	+	1
2x 19W - NV-LED			55		2
4400 Lumen			62		3
2700 Kelvin			79		4
CRI >90					5
Dimmer					

112076 optionale Acrylscheibe

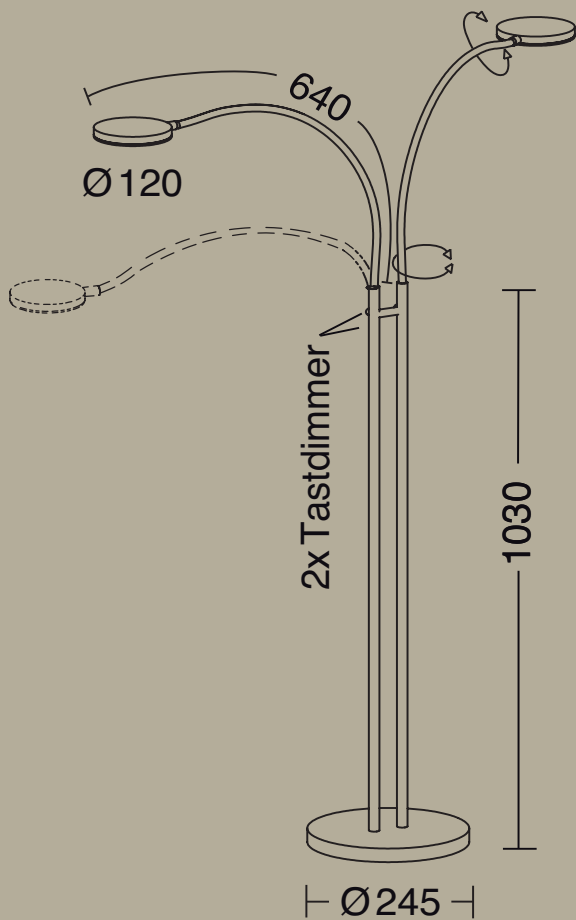

flex t

Technische Daten Artikel + Oberfläche + Flexschlauch

1x LED
 19W - NV-LED
 2200 Lumen
 2700 Kelvin
 Dimmer

9921-1

19



1



55



2



62



3



79



4



5

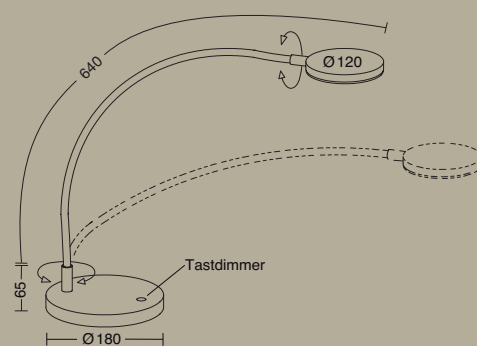

112076

optionale Acrylscheibe



9921-1-555

flex k

Technische Daten Artikel + Oberfläche + Flexschlauch

1x LED
 19W - NV-LED
 2200 Lumen
 2700 Kelvin
 Dimmer

Artikel	Oberfläche	Flexschlauch
9926-1	19 	1 
	55 	2 
	62 	3 
	79 	4 
		5 

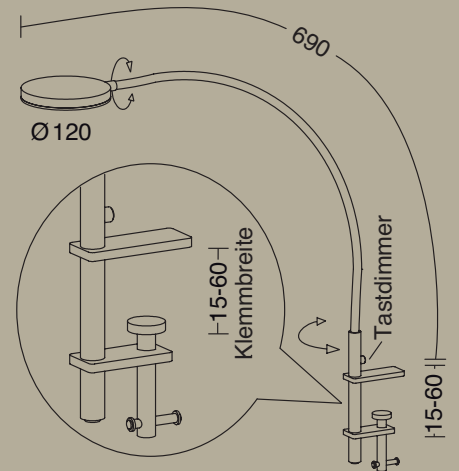

112076 optionale Acrylscheibe



9926-1-792

flex w

Technische Daten Artikel + Oberfläche + Flexschlauch

1x LED
 12W - 230V
 1130 Lumen
 2700 Kelvin
 CRI >90
 Dimmer

9922-1

19 

1 

55 

2 

62 

3 

79 

4 

5 

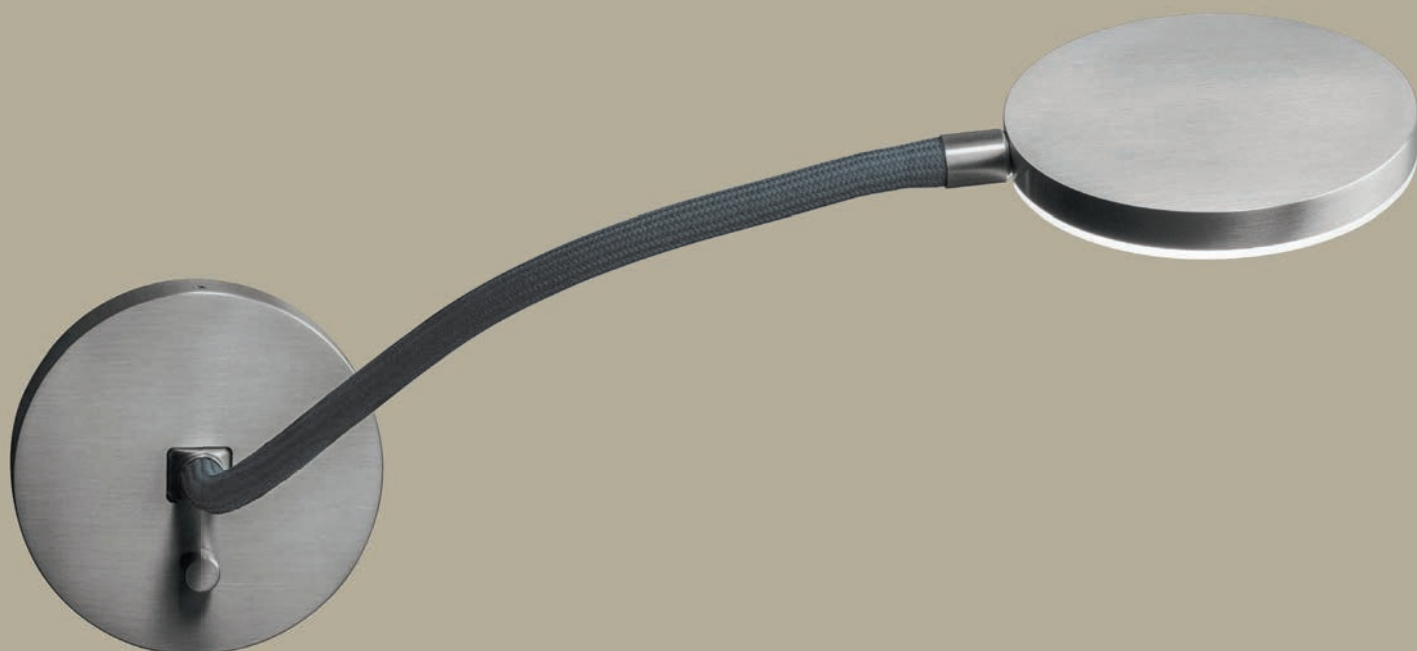
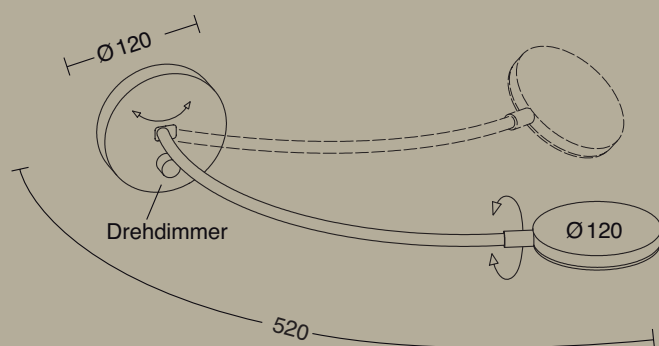

9922-1-794



9922-1-625

flex d3

Technische Daten Artikel + Oberfläche + Flexschlauch

3x LED
3x 12W - 230V
3390 Lumen
2700 Kelvin
CRI >90
Dimmbar

9923-3

19



1

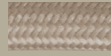

55



2



62



3



79



4



5

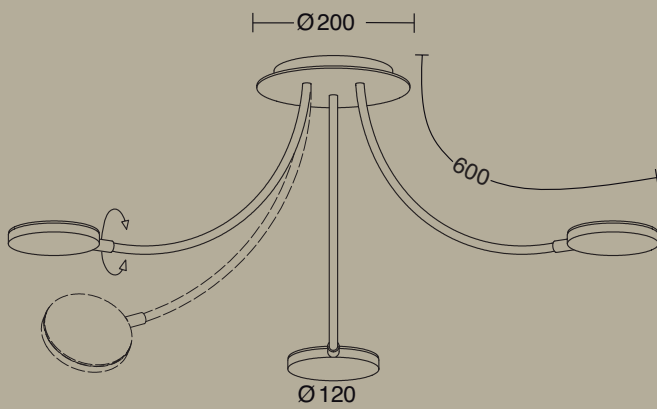

9923-3-625

flex d5

Technische Daten Artikel + Oberfläche + Flexschlauch

5x LED
 5x 12W - 230V
 5650 Lumen
 2700 Kelvin
 CRI >90
 Dimmbar

Artikel	Oberfläche	Flexschlauch
9925-5	19 	1 
55		2 
62		3 
79		4 
		5 

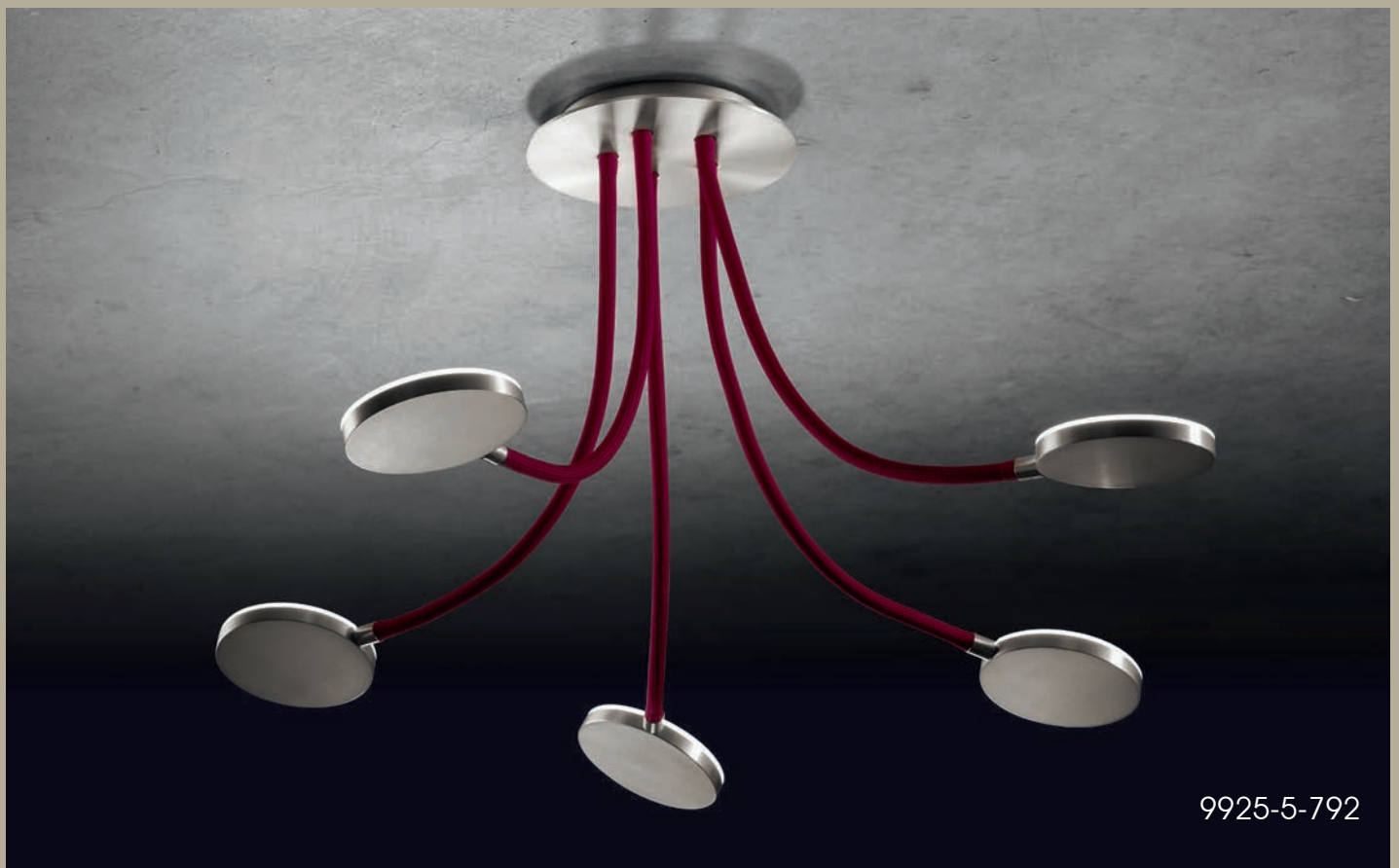
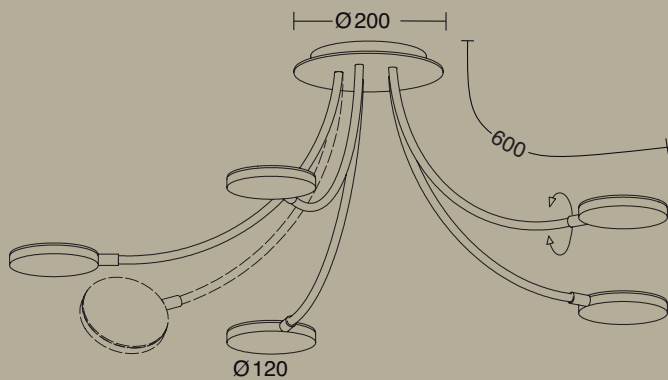

9925-5-792



9908-2-625

nova flex

Technische Daten

1x LED
48W - NV-LED
6500 Lumen
2700 Kelvin
Dimmer

Artikel + Oberfläche + Flexschlauch

Artikel	Oberfläche	Flexschlauch
9908-2	19 	1 
	55 	2 
	62 	3 
	79 	4 
		5 

Technische Daten

Seitenarm
1x LED
19W - NV-LED
2200 Lumen
2700 Kelvin
Dimmer

112076 optionale Acrylscheibe

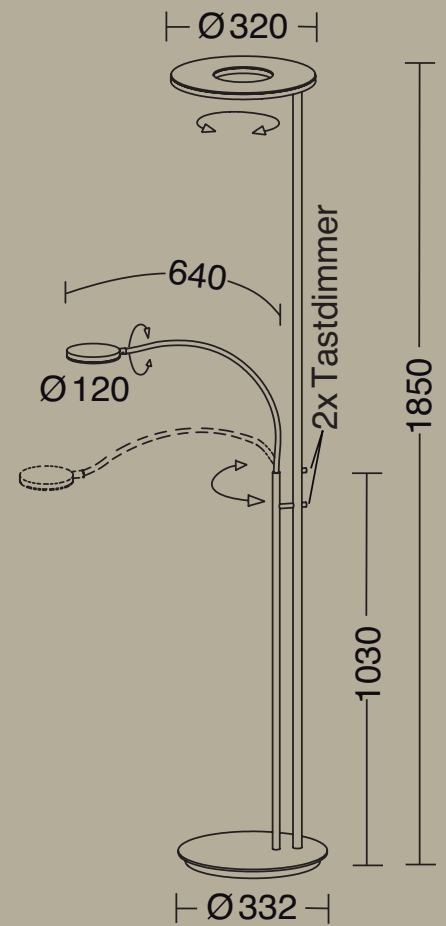

vita

Vita P

Technische Daten 208

Vita 3

Technische Daten 209

Vita 6

Technische Daten 210-211

vita p

Technische Daten

3x E27
230V



5302-3-69 +
751-60-23

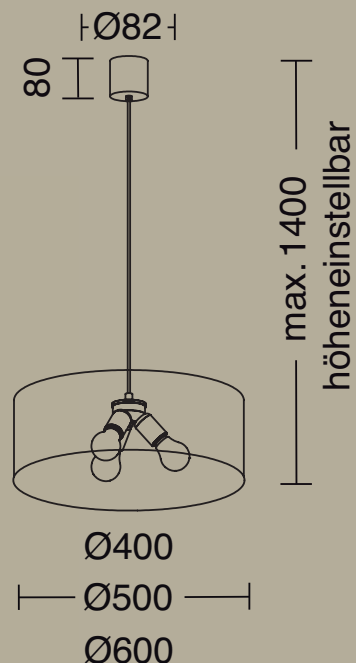

Ausführung

● 5302-3-69 Nickel matt

+ Chintz-Schirme

Ø 400 mm - max. 3x 40W

- 751-40-12 Hellgrau
- 751-40-17 Wellenoptik Weiß
- 751-40-23 Schiefer
- 751-40-4 Champagner
- 751-40-41 Sand
- 751-40-7 Weiß
- 751-40-80 Blattsilber
- 751-40-90 Blattgold

+ Chintz-Schirme

Ø 500 mm - max. 3x 60W

- 751-50-12 Hellgrau
- 751-50-17 Wellenoptik Weiß
- 751-50-23 Schiefer
- 751-50-4 Champagner
- 751-50-41 Sand
- 751-50-7 Weiß
- 751-50-80 Blattsilber
- 751-50-90 Blattgold

+ Chintz-Schirme

Ø 600 mm - max. 3x 60W

- 751-60-12 Hellgrau
- 751-60-17 Wellenoptik Weiß
- 751-60-23 Schiefer
- 751-60-4 Champagner
- 751-60-41 Sand
- 751-60-7 Weiß
- 751-60-80 Blattsilber
- 751-60-90 Blattgold

vita 3

Technische Daten

3x E27
230V

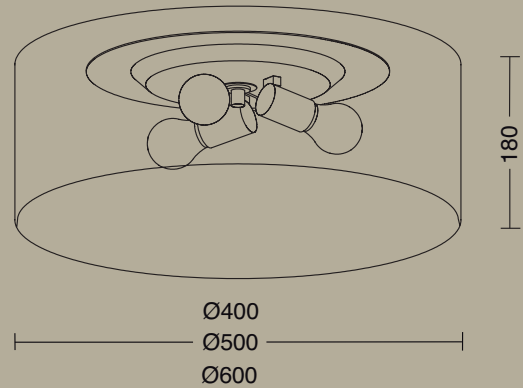

5301-3-8 +
750-50-80

5301-3-8 +
750-60-4



Ausführung

● 5301-3-8 Weiß

+ Chintz-Schirme

Ø 400 mm - max. 3x 40W

- 750-40-12 Hellgrau
- 750-40-17 Wellenoptik Weiß
- 750-40-23 Schiefer
- 750-40-4 Champagner
- 750-40-41 Sand
- 750-40-7 Weiß
- 750-40-80 Blattsilber
- 750-40-90 Blattgold

+ Chintz-Schirme

Ø 500 mm - max. 3x 60W

- 750-50-12 Hellgrau
- 750-50-17 Wellenoptik Weiß
- 750-50-23 Schiefer
- 750-50-4 Champagner
- 750-50-41 Sand
- 750-50-7 Weiß
- 750-50-80 Blattsilber
- 750-50-90 Blattgold

+ Chintz-Schirme

Ø 600 mm - max. 3x 60W

- 750-60-12 Hellgrau
- 750-60-17 Wellenoptik Weiß
- 750-60-23 Schiefer
- 750-60-4 Champagner
- 750-60-41 Sand
- 750-60-7 Weiß
- 750-60-80 Blattsilber
- 750-60-90 Blattgold

vita 6

Technische Daten

6x E27
230V

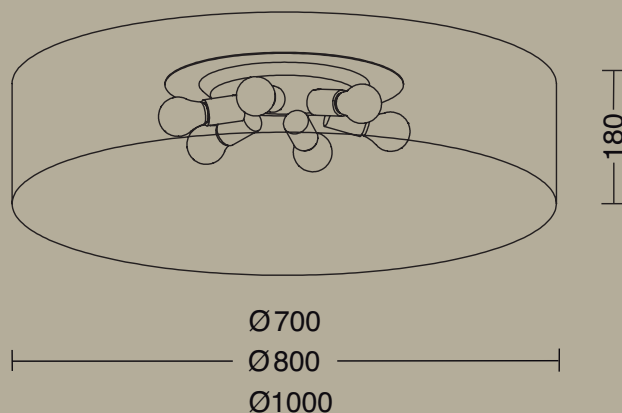

5306-6-8 +
750-70-17

Ausführung

● 5306-6-8 Weiß

+ Chintz-Schirme

Ø 700 mm - max. 6x 40W

- 750-70-12 Hellgrau
- 750-70-17 Wellenoptik Weiß
- 750-70-23 Schiefer
- 750-70-4 Champagner
- 750-70-41 Sand
- 750-70-7 Weiß
- 750-70-80 Blattsilber
- 750-70-90 Blattgold

+ Chintz-Schirme

Ø 800 mm - max. 6x 60W

- 750-80-12 Hellgrau
- 750-80-17 Wellenoptik Weiß
- 750-80-23 Schiefer
- 750-80-4 Champagner
- 750-80-41 Sand
- 750-80-7 Weiß
- 750-80-80 Blattsilber
- 750-80-90 Blattgold

+ Chintz-Schirme

Ø 1000 mm - max. 6x 60W

- 750-100-12 Hellgrau
- 750-100-17 Wellenoptik Weiß
- 750-100-23 Schiefer
- 750-100-4 Champagner
- 750-100-41 Sand
- 750-100-7 Weiß
- 750-100-80 Blattsilber
- 750-100-90 Blattgold



5306-6-8 +
750-80-23



5306-6-8 +
750-100-4

fifties

Fifties 3-flammig

Milieubild

214-215

Technische Daten

216-217

Fifties 2-flammig

Technische Daten

218-219

Fifties 1-flammig

Technische Daten

220-221

fifties



6355-3-58 + 755-18-14 + 755-18-15 + 755-18-22



fifties 3-flammig

Technische Daten

3x E27
 nur LED-Leuchtmittel
 230V
 3x Ein-/Ausschalter

Ausführungen

- 6355-3-55 Schwarz
- 6355-3-58 Fumé matt
- 6355-3-69 Nickel matt
- 6355-3-9 Messing pol./matt

Chintz-Schirme

- 755-18-12 Hellgrau
- 755-18-14 Orange
- 755-18-15 Gelb
- 755-18-16 Rosa
- 755-18-18 Waldgrün
- 755-18-19 Dunkelblau
- 755-18-22 Hellgrün
- 755-18-23 Schiefer
- 755-18-4 Champagner
- 755-18-41 Sand
- 755-18-42 Taupe
- 755-18-43 Dunkelrot
- 755-18-46 Hellrosa
- 755-18-47 Hellblau
- 755-18-48 Hellmint
- 755-18-55 Schwarz
- 755-18-7 Weiß

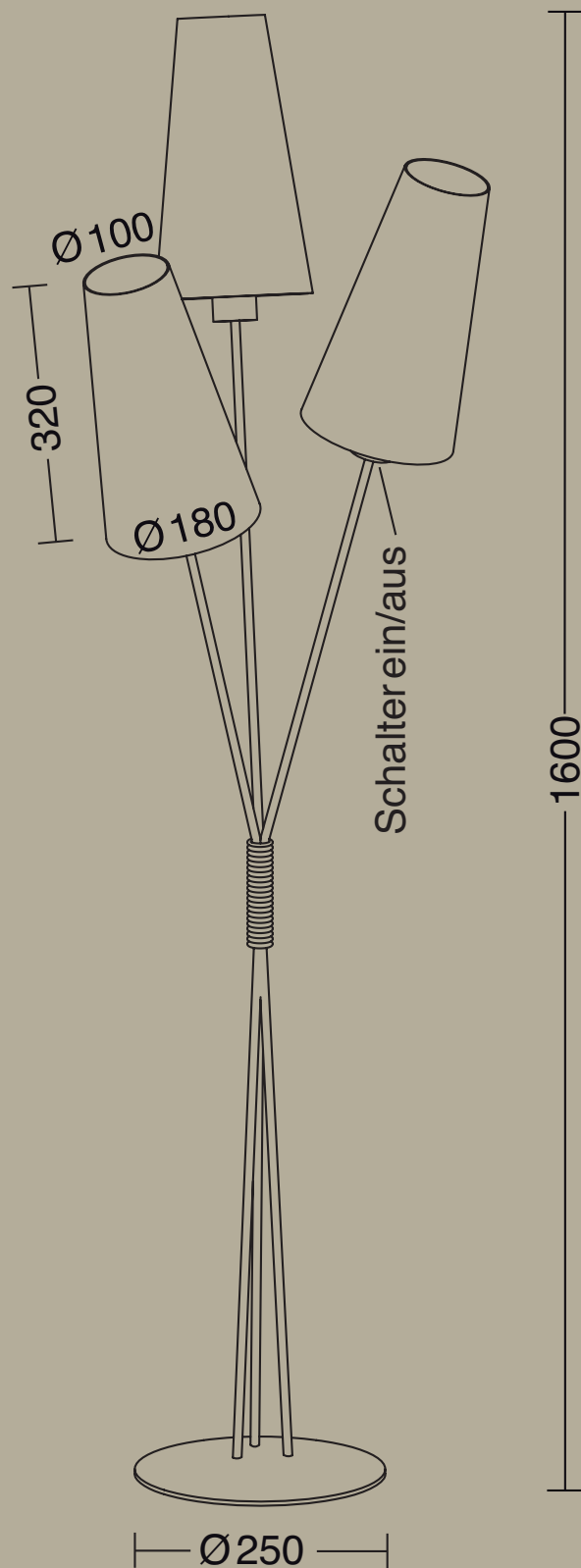



6355-3-58 + 755-18-16 + 755-18-4 + 755-18-41



6356-2-55 + 755-18-18 + 755-18-22

fifties 2-flammig

Technische Daten

2x E27
nur LED-Leuchtmittel
230V
2x Ein-/Ausschalter

Ausführungen

- 6356-2-55 Schwarz
- 6356-2-58 Fumé matt
- 6356-2-69 Nickel matt
- 6356-2-9 Messing pol./matt

Chintz-Schirme

- 755-18-12 Hellgrau
- 755-18-14 Orange
- 755-18-15 Gelb
- 755-18-16 Rosa
- 755-18-18 Waldgrün
- 755-18-19 Dunkelblau
- 755-18-22 Hellgrün
- 755-18-23 Schiefer
- 755-18-4 Champagner
- 755-18-41 Sand
- 755-18-42 Taupe
- 755-18-43 Dunkelrot
- 755-18-46 Hellrosa
- 755-18-47 Hellblau
- 755-18-48 Hellmint
- 755-18-55 Schwarz
- 755-18-7 Weiß

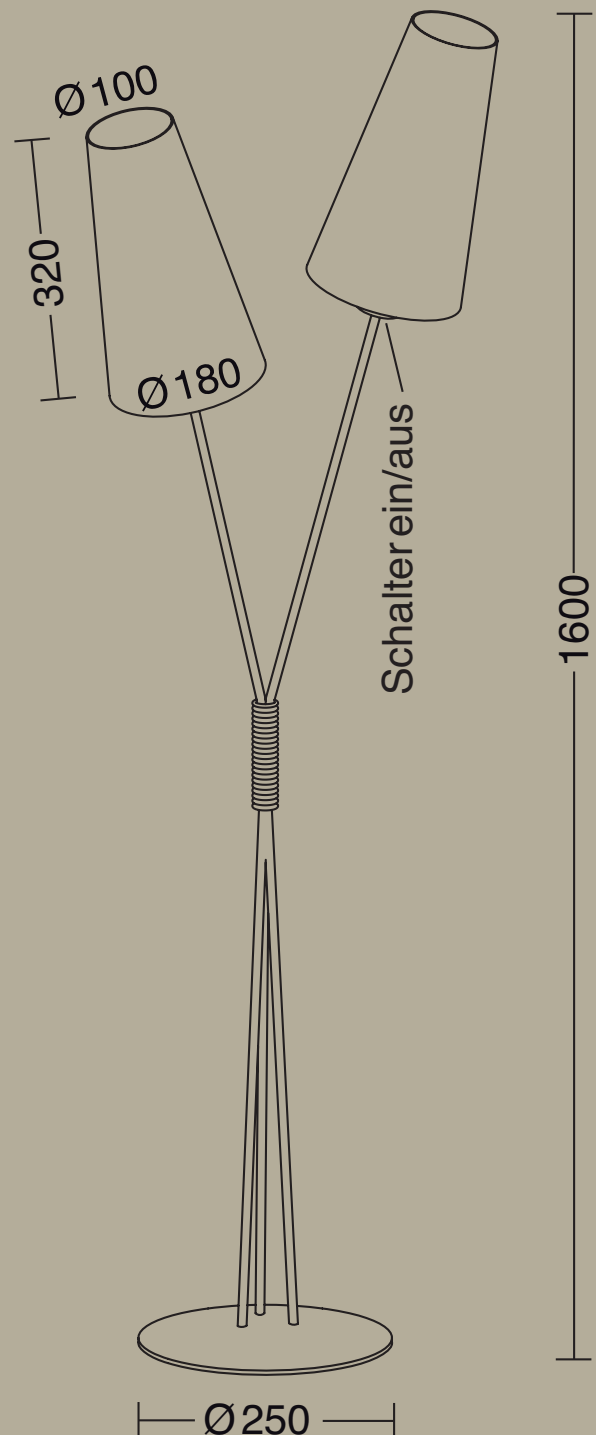



6357-1-9 + 755-18-22

fifties 1-flammig

Technische Daten

1x E27
nur LED-Leuchtmittel
230V
Ein-/Ausmacher

Ausführungen

- 6357-1-55 Schwarz
- 6357-1-58 Fumé matt
- 6357-1-69 Nickel matt
- 6357-1-9 Messing pol./matt

Chintz-Schirme

- 755-18-12 Hellgrau
- 755-18-14 Orange
- 755-18-15 Gelb
- 755-18-16 Rosa
- 755-18-18 Waldgrün
- 755-18-19 Dunkelblau
- 755-18-22 Hellgrün
- 755-18-23 Schiefer
- 755-18-4 Champagner
- 755-18-41 Sand
- 755-18-42 Taupe
- 755-18-43 Dunkelrot
- 755-18-46 Hellrosa
- 755-18-47 Hellblau
- 755-18-48 Hellmint
- 755-18-55 Schwarz
- 755-18-7 Weiß

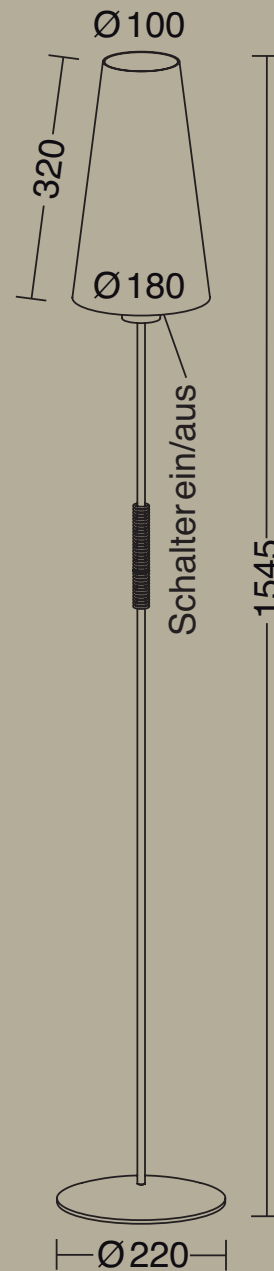

holtkötter klassik

Produktionsbilder Holtkötter Klassik	224-225
Boyleuchte Technische Daten	226-227
2527 Technische Daten	228
9617 Technische Daten	229
9614 Milieubild	230-231
9614 Technische Daten	232
9615 Technische Daten	233
6263 Technische Daten	234
6354 Technische Daten	235
6348 Technische Daten	236
2541 Technische Daten	237



Messing ist eine Kupfer-Zink-Legierung. Wird diese mit Silberlot
hart verlötet, ergibt sich eine besonders hohe Festigkeit.

holtkötter klassik



Messing poliert: Um diese hochwertige Oberfläche zu erhalten, wird das Messing in mehreren Schritten per **Handarbeit** und mit viel Fingerspitzengefühl auf **Hochglanz poliert.** So erhalten unsere klassischen Leuchten ihr edles und zeitloses Aussehen.



boyleuchte

Technische Daten

1x E27
nur LED-Leuchtmittel
230V
Ein-/Auswechsler

Ausführungen

● 6370-1-55	Schwarz
● 6370-1-58	Fumé matt
● 6370-1-69	Nickel matt
● 6370-1-99	Messing matt

Chintz-Schirme Ø 160mm

● 715-16-4	Champagner
● 715-16-41	Sand
● 715-16-7	Weiß

Chintz-Schirme Ø 260mm

● 716-26-4	Champagner
● 716-26-41	Sand
● 716-26-7	Weiß

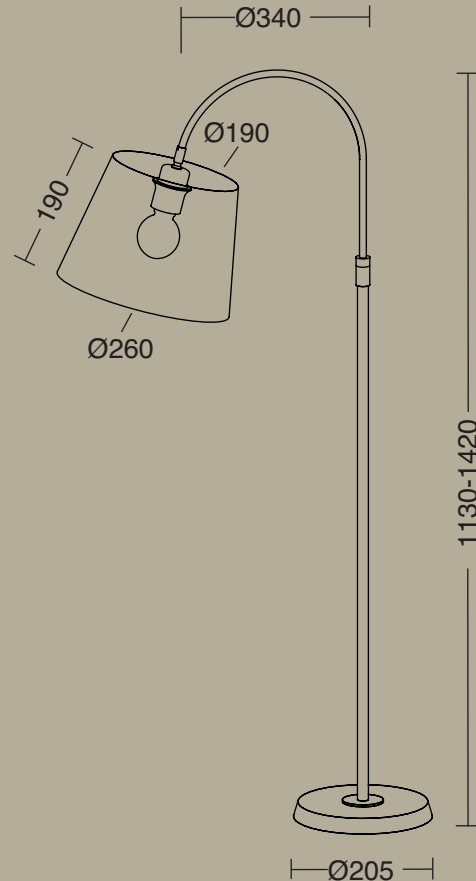
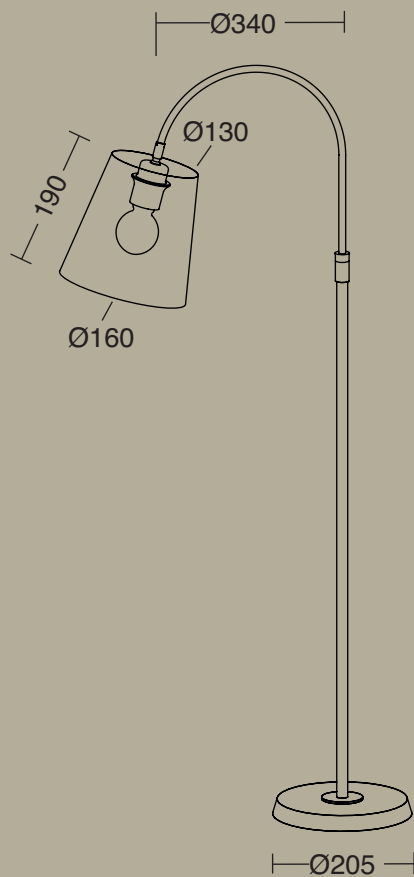

2527

Technische Daten

1x E27 max. 100W

230V

Zugschalter

Ausführungen

- 2527-1-3 Messing antik
- 2527-1-69 Nickel matt
- 2527-1-99 Messing matt

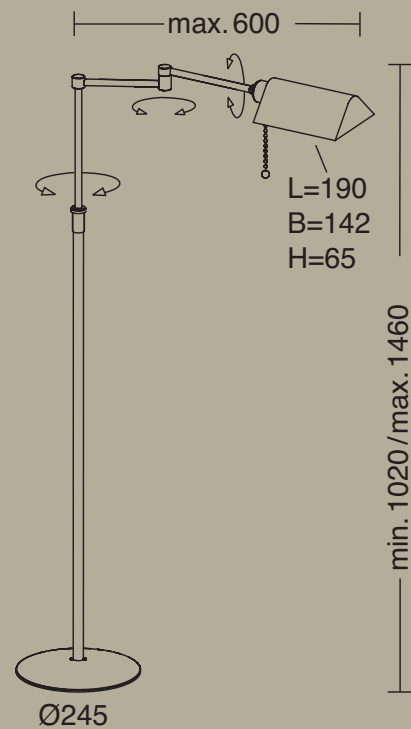

9617

Technische Daten

1x LED
19W - NV-LED
2200 Lumen
2700 Kelvin
CRI >90
Dimmer

Ausführungen

- 9617-1-53 Fumé matt
- 9617-1-69 Nickel matt
- 9617-1-9 Messing pol./ matt

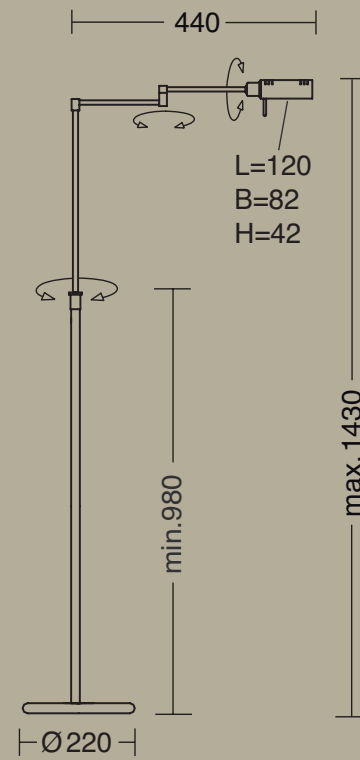

9617-1-69

9614



9614-1-9



9614

Technische Daten

1x LED
19W - NV-LED
2200 Lumen
2700 Kelvin
CRI >90
Dimmer

Ausführungen

- 9614-1-53 Fumé matt
- 9614-1-69 Nickel matt
- 9614-1-9 Messing pol./ matt

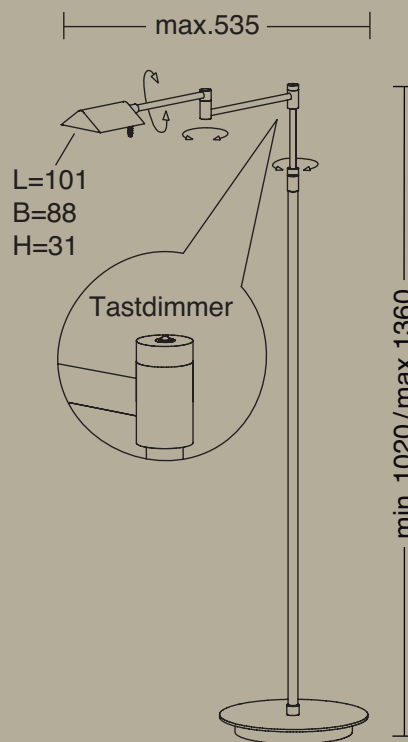

9615

Technische Daten

1x LED
14W - NV-LED
2000 Lumen
2700 Kelvin
CRI >90
Dimmer

Ausführungen

- 9615-1-53 Fumé matt
- 9615-1-69 Nickel matt
- 9615-1-9 Messing pol./ matt

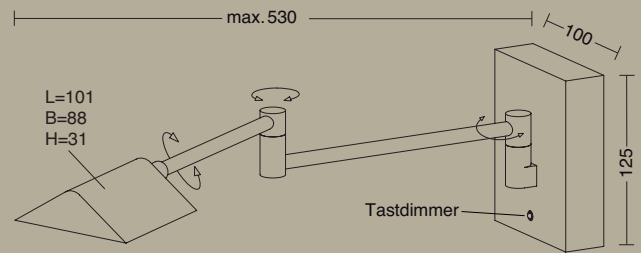

9615-1-9

6263

Technische Daten

1x E27 max. 75W
230V
Ein-/Ausschalter

Ausführungen

6263-1-69 Nickel matt
6263-1-99 Messing matt

Chintz-Schirme Ø 150mm

711-15-4 Chintz Champagner
711-15-41 Chintz Sand
711-15-7 Chintz Weiß

Chintz-Schirme Ø 300mm

713-30-4 Chintz Champagner
713-30-41 Chintz Sand
713-30-7 Chintz Weiß

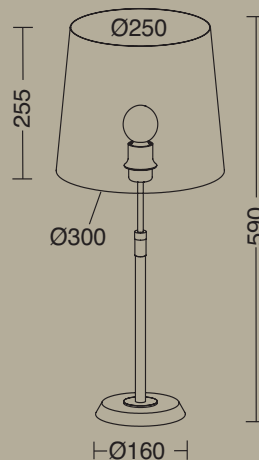
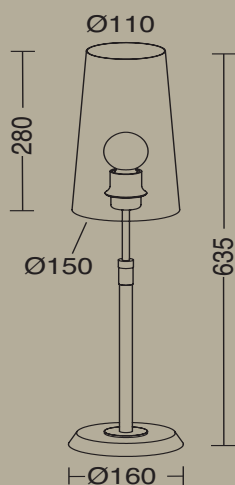

6263-1-99 +
711-15-41



6263-1-69 +
713-30-4

6354

Technische Daten

1x E27 max. 75W
230V
Ein-/Ausschalter

Ausführungen

● 6354-1-58 Fumé matt
● 6354-1-69 Nickel matt
● 6354-1-99 Messing matt

Chintz-Schirme Ø 180mm

● 710-18-4 Chintz Champagner
● 710-18-41 Chintz Sand
● 710-18-7 Chintz Weiß

Chintz-Schirme Ø 380mm

● 712-38-4 Chintz Champagner
● 712-38-41 Chintz Sand
● 712-38-7 Chintz Weiß

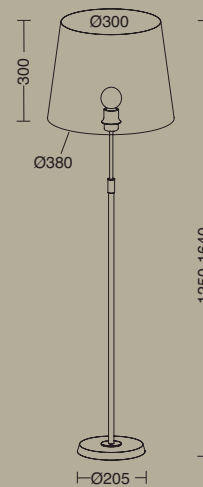
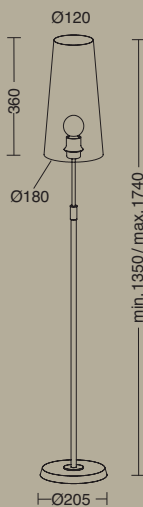

6354-1-69 +
710-18-7



6354-1-99 +
712-38-4

6348

Technische Daten

1x E27 max. 75W

230V

Ein-/Ausshalter

Ausführungen

- 6348-1-58 Fumé matt
- 6348-1-69 Nickel matt
- 6348-1-9 Messing pol. / matt

Chintz-Schirme Ø 380mm

- 709-38-4 Chintz Champagner
- 709-38-41 Chintz Sand
- 709-38-7 Chintz Weiß

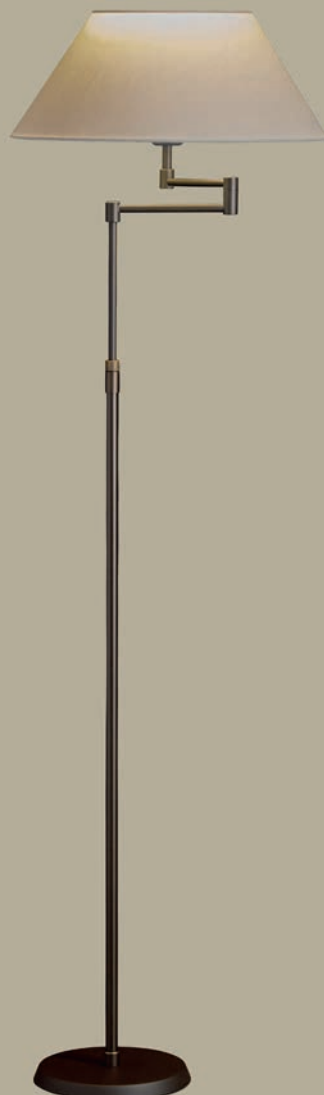
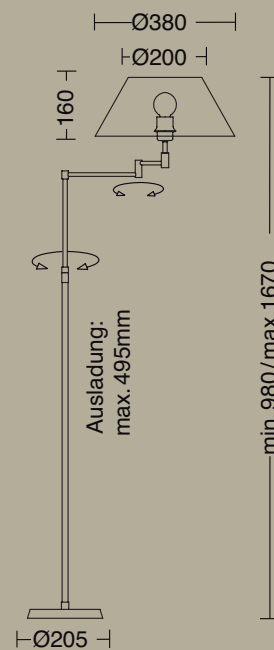

6348-1-58 +
709-38-41

2541

Technische Daten

2x E27 max. 2x 60W
230V
Zugschalter

Ausführungen

- 2541-2-3 Messing antik
- 2541-2-69 Nickel matt
- 2541-2-9 Messing pol./matt

Chintz-Schirme Ø 400mm

- 724-40-4 Chintz Champagner
- 724-40-41 Chintz Sand
- 724-40-7 Chintz Weiß

Chintz-Schirme Ø 500mm

- 704-50-4 Chintz Champagner
- 704-50-41 Chintz Sand
- 704-50-7 Chintz Weiß

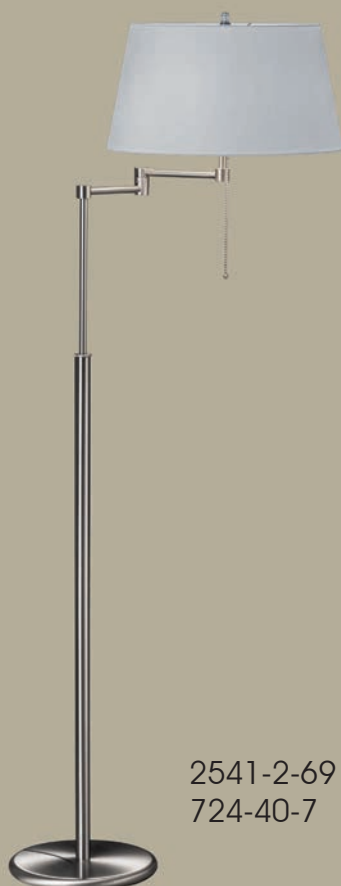
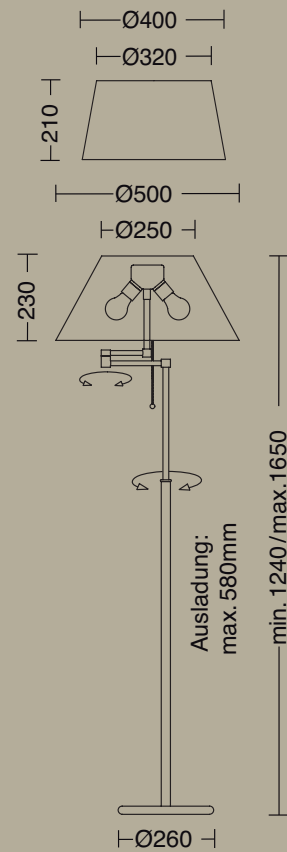

2541-2-69 +
724-40-7

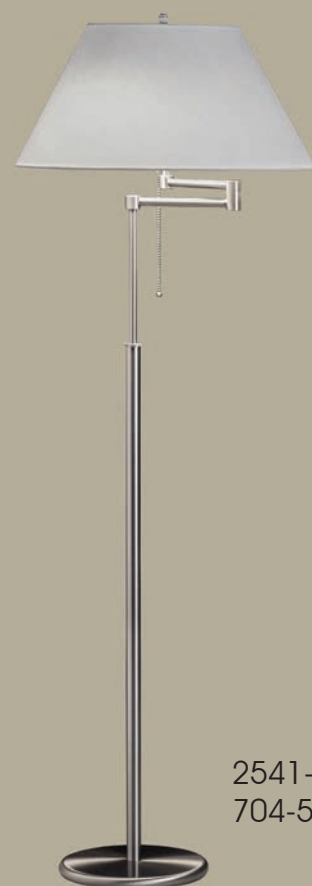

2541-2-69 +
704-50-7

Artikelnummer.....Seite

2020 AURA S.....	140	2190 SUPERNOVA GT.....	99
2022 AURA P2.....	144	2309 XENA XS.....	127
2023 AURA P3.....	146	2312 XENA S.....	127
2025 AURA R3.....	146	2316 XENA L.....	127
2026 AURA E.....	142	2321 AVIOR S.....	121
2027 AURA A.....	142	2322 AVIOR M.....	121
2028 AURA P1.....	142	2323 AVIOR L.....	121
2040 VINCE S.....	97	2404 FIDELIO.....	44-48
2050 FAVOR S.....	55	2410 PLISSEE S.....	10
2051 FAVOR.....	57	2411 PLISSEE T1.....	14
2052 FAVOR.....	58	2412 PLISSEE T2.....	19
2053 FAVOR.....	60	2413 PLISSEE W.....	20
2120 SUPERNOVA P.....	88	2414 PLISSEE D.....	25
2121 SUPERNOVA PW.....	88	2527.....	228
2130 SUPERNOVA D.....	84	2541.....	237
2131 SUPERNOVA DW.....	84	5301 VITA 3.....	209
2140 SUPERNOVA W.....	103	5302 VITA P.....	208
2141 SUPERNOVA WD.....	103	5306 VITA 6.....	210
2145 SUPERNOVA S.....	95	5320 LIV.....	31
2146 SUPERNOVA T.....	100	5320 GOLYO.....	34
2155 SUPERNOVA DTW.....	95	6263.....	234
2160 SUPERNOVA DL.....	104	6348.....	236
2165 ORBIT.....	105	6354.....	235
2171 JANUS E.....	76	6355.....	216
2173 JANUS K.....	77	6356.....	219
2183 JANUS H.....	74	6357.....	221

Artikelnummer.....Seite

6370 BOYLEUCHTE.....	227	9930 TYPE S.....	110
9231 EPSILON.....	135	9931 TYPE T.....	112
9232 EPSILON.....	135	9940 NAXOS.....	68
9236 EPSILON.....	135		
9614.....	232		
9615.....	233		
9617.....	229		
9652 PLANO TWIN.....	176		
9656 PLANO B.....	173		
9657 PLANO T.....	178		
9658 PLANO WB.....	182		
9659 PLANO S.....	175		
9901 PLANO.....	180		
9906 NOVA.....	160		
9907 NOVA OOG.....	155		
9908 NOVA FLEX.....	205		
9909 NOVA PLANO.....	165		
9914 PLANO WD.....	185		
9915 PLANO W.....	184		
9920 FLEX S.....	192		
9921 FLEX T.....	198		
9922 FLEX W.....	200		
9923 FLEX D3.....	202		
9924 FLEX TWIN.....	197		
9925 FLEX D5.....	203		
9926 FLEX K.....	199		

NOTIZEN

A series of horizontal dotted lines for writing notes.

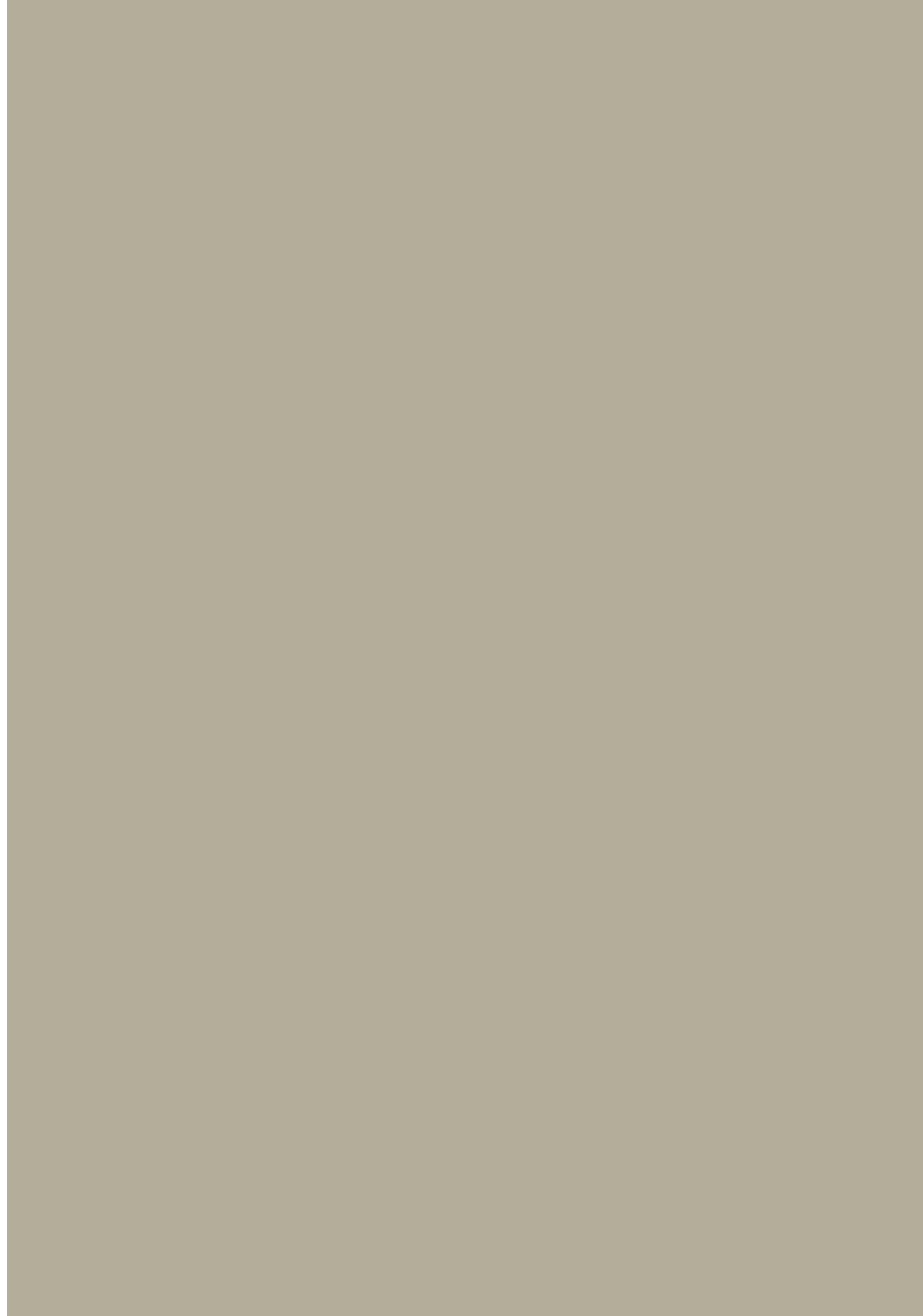

QUALITÄT MADE IN GERMANY



HOLTKÖTTER LICHT GMBH / Waldliesborner Straße 45 / D-59329 Wadersloh

T +49 (0) 2523 9825 0 / F +49 (0) 2523 9825 50 / www.holtkoetter.de